

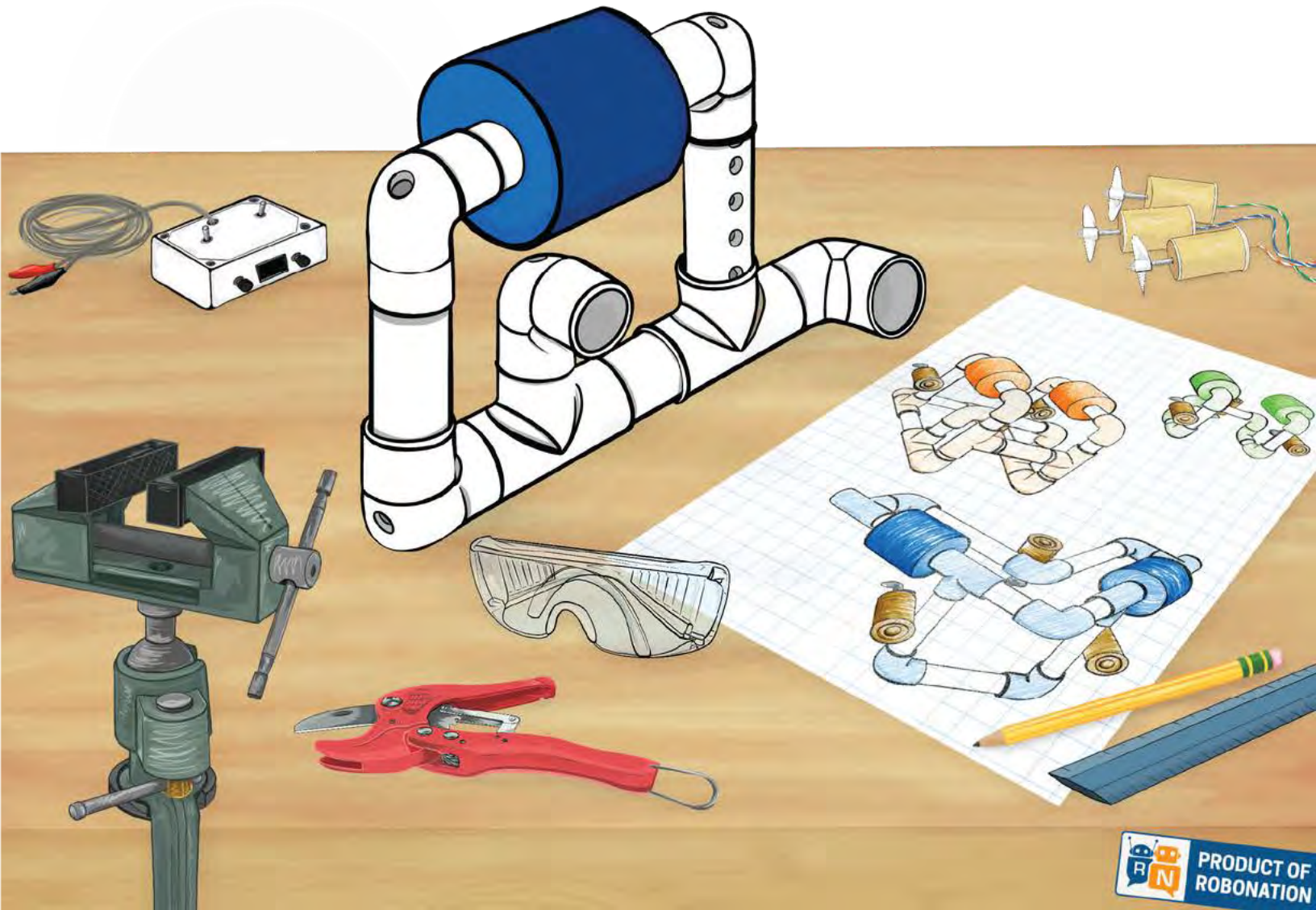

# seaperch™

## Build Manual





# SeaPerch Build Manual

## Introduction

**Plunge into the world of robotics with SeaPerch! We're so glad you're here.**

SeaPerch is an innovative robotics program that equips students, educators, and parents with the resources they need to build an underwater remotely operated vehicle (ROV) in an in- or out-of-school setting. At RoboNation we like to say, **“Build a Bot. Change the World.”** As an integrated STEM education program, SeaPerch is a great place to start on your journey to build a bot and learn how to use that bot for good. Welcome to the start of that journey.

SeaPerch is an ROV, a community, and a competition that aims to engage students and educators in inquiry-based learning with real-world applications. The program introduces students to basic engineering, design, and science concepts and is a great addition to traditional and informal educational settings. By navigating a SeaPerch build from start to finish, students are introduced to a variety of STEM and real-world content and skills in an engaging, project-based learning activity. As a fun hands-on project, SeaPerch fosters key 21st century skills including critical thinking, collaboration, and creativity.

Beyond the experience of building an underwater ROV, SeaPerch provides a community of students, educators, mentors, and advocates to provide support along the way. Whether you are looking for a fun project at home, an educational program to enhance your classroom curriculum, or a group of people who enjoy tinkering, SeaPerch is for you.

As you embark on your SeaPerch ROV build, refer to our website, [seaperch.org](http://seaperch.org), where you will find extension activities, standards mappings, and other educational resources. New content is added frequently.

## Welcome to the first step on your SeaPerch journey. Have fun!



### USING THIS BUILD MANUAL

This manual contains detailed step-by-step instructions, supporting images, and enhanced graphics to guide you through your build process. Sections 1-3 may be completed in any order and the time estimates provided are general guidelines for planning purposes. You may take less or more time depending on your experience, the size of your group, and/or incorporation of extension activities. It's possible to complete a build in 1 day or to extend it over a period of months.

**Building an ROV following this manual is only the first step.** SeaPerch is an engineering design project, so we challenge you to design your own novel frame design based on a problem or challenge that interests you (learn more in Section 5). We've provided three ROV frame designs using the materials provided in one SeaPerch kit to get you started but we want to see what you come up with next.









This **safety bot** will provide you with important safety reminders.



This **info bot** will share tips and tricks that will help you throughout your build.

# SeaPerch Build Manual

## Contents

	<b>Tool Usage, Skills, and Safety</b> .....	<b>1</b>
	Safety first! Familiarize yourself with safety guidelines and appropriate tool usage.	
	<b>Controller Assembly</b> .....	<b>15</b>
	Mount and solder electrical components and connect the power cable.	
	<b>Thruster Assembly</b> .....	<b>31</b>
	Build and waterproof your thrusters and connect the tether cable.	
	<b>Frame Assembly</b> .....	<b>47</b>
	Construct and assemble the body of your SeaPerch ROV.	
	<b>Final Assembly</b> .....	<b>63</b>
	Put all the components together and get your SeaPerch ROV in the water.	
	<b>Engineering Design</b> .....	<b>73</b>
	Design, build, and test your own unique SeaPerch ROV design.	



## ACKNOWLEDGEMENTS

This build manual was made possible by a team of people representing **RoboNation**, including dedicated staff members and interns. Cover design and artwork was provided by Tiff Ullman and photography was provided by Kaelan & Daniel Young.

We would like to extend our great appreciation to the **SeaPerch advocates** who participated in the review of this manual at various stages of development.

We also want to acknowledge the generous support from the **Office of Naval Research** for funding the SeaPerch program.

For more information, contact us at [seaperch@robonation.org](mailto:seaperch@robonation.org). We're here to help and look forward to hearing from you!

# SeaPerch Build Manual

## Tool Usage, Skills, and Safety



### SECTION OBJECTIVE

**Safety First!** Before beginning your SeaPerch build, carefully review this section to ensure all participants (adults and students) are familiar with the general safety guidelines as well as the safe use of the tools and battery required to construct the ROV.



## Preparing for a Safe, Successful Build

SeaPerch ROVs are often built by a team of two or three students. For efficiency, arrange to obtain enough tools to ensure that students are not delayed during the build process waiting for availability of needed tools.

**Tools:** Each team should have a set of basic tools that includes a screwdriver, diagonal cutting pliers, needle-nose pliers, wire stripper, and soldering iron. Tools such as pliers, pipe cutters, electric drills, and de-soldering pump could be shared among several teams.

**Workspace:** Each team should have a sturdy desk, lab table, or workbench. The desk should be large enough to accommodate the number of students and mentors working in the group with room for the materials, tools, and an active work area. A 3' x 5' area is usually sufficient. The top should be  $\frac{3}{4}$ " to 2" thick to accommodate the table vise. Plastic tables are not recommended because the vise can easily slip off.

**Table cover:** A disposable cover like newspaper, butcher paper, cardboard, or a lab bench cover should be used to protect each work surface, especially while encapsulating the motors in wax.

**Power source:** Each workstation should have an extension cord or outlet strip suitable for the soldering iron and power drill. Extension cords or power strip cords should be secured to the workstation frame to prevent pulling the connected tool off the workstation. Cords crossing traffic areas should be properly secured and covered to avoid creating a trip hazard.

**Accommodations:** Using the kits and tools with younger students or with students who require special accommodations may require modification as well as additional supervision. Suggestions include, at a minimum:

- Pre-cut the PVC pipe
- Pre-drill the PVC pipe
- Pre-solder the controllers
- Keep the group size small (a maximum of three students per kit)
- Have at least one adult assigned to each small group of students

*These are recommendations and additional modifications may be necessary based upon unique needs or circumstances. Please follow the safety rules and guidelines provided by your school, club, or organization.*

## General Safety

The following general safety guidelines should be observed throughout the build:

- Appropriately sized safety glasses should always be worn by students, teachers, and other helpers, even over prescription eyewear, and should meet the ANSI Z87+ Standard. Although some procedures do not usually involve significant eye hazards, the students often work close to others, who at any time may be performing more potentially hazardous steps. Activities such as soldering, cutting, drilling, and applying adhesives can easily cause materials to fly significant distances.
- Keep the workstation clear and orderly. Only place the materials and tools needed for the section you are working on in front of you.
- Have a first aid kit readily available.
- Avoid eating or drinking during the ROV build.
- Secure loose clothing, remove dangling jewelry (necklaces, earrings, bracelets, etc.), and tie back long hair.
- Wear closed-toe shoes during the build.
- Exercise caution and stay aware of the movement of others while near the edge of the pool, dock, or other water-side location. Wearing a personal flotation device is recommended (and often required by law) if operating the ROV from a pier or boat. Wearing rubber-soled shoes is recommended when near water to minimize the risk of slips and falls.
- The SeaPerch uses a 12-volt direct current (VDC) power system that does not pose a danger to swimmers/divers who are in the water with the ROV if basic safety precautions are observed.
  - Swimmers should stay at least 10 feet away from the SeaPerch ROV and remain aware of the tether cable's location in the water to avoid entanglement.
  - If the ROV must be retrieved from the water with the assistance of a swimmer/diver, the tether cable should be unplugged from the controller before the swimmer/diver approaches the ROV.
- The tether cable should always be unplugged from the controller before removing the SeaPerch from the water to prevent accidental injury from the spinning propellers.
- Avoid contact with the propellers when the tether cable is connected to the controller to avoid cuts and other injuries.

## Tool Usage and Safety

The tools used during a SeaPerch build require manual dexterity and strength as well as good hand-eye coordination. Familiarize all participants with the safe operation of these tools before beginning.

### Soldering Iron

A soldering iron (Figure 1) is a hand tool with a pointed, heated tip used to melt solder, a metal alloy with a low melting point. Using the soldering iron to melt solder establishes electrical continuity and secures the components to the printed circuit board (PCB).

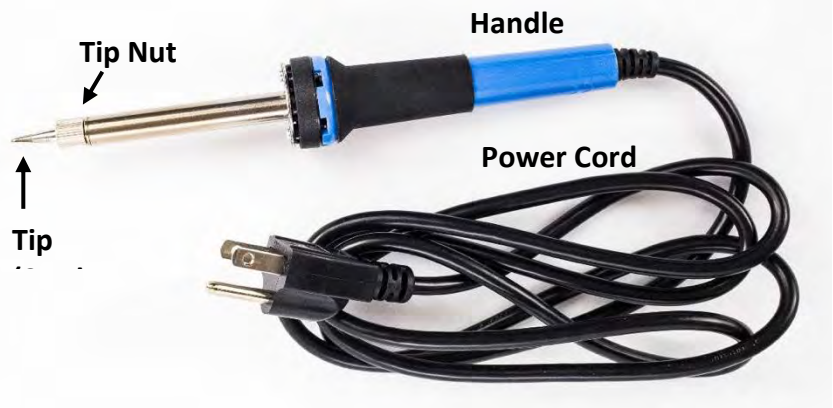

Figure 1

### Safety Information:

- Safety glasses should always be worn when using this tool. Solder contains rosin flux in its core to help clean the electrical connections and help the solder to adhere to the metal properly. Small amounts of flux can occasionally pop out of the melting solder and sometimes travel far enough to reach the eye of the person soldering or someone nearby.
- Solder should never be placed in one's mouth.
- Hands should always be washed after working with solder.
- Work in a well-ventilated area and avoid breathing the smoke from the melting flux from inside the solder.
- The soldering iron and the stand will get **very hot**. Do not touch any of the metal parts of the soldering iron or the stand. Even brief contact with skin can cause third degree burns.
- Do not touch the tip area of a soldering iron, even when it appears to be off or unplugged, as it does not look different when it is hot compared to when it is cold.
- When not in use, the soldering iron should always be placed in the stand. Never set it down on a tabletop or workstation where it could burn or ignite anything it touches.
- The soldering iron and the stand can remain hot for 10 minutes or more after use. Always allow the soldering iron and the stand to cool completely before changing the tip or returning it to its storage location.
- Connections should be allowed to cool after soldering before they are moved or touched.
- Do not pass a hot soldering iron from user to user. Place the soldering iron in the stand and allow the next user to pick it up.
- Solder over the workstation, not your lap/legs if sitting down. Hot solder can drip from the tip of the iron and cause burns.

### Soldering Iron Set-Up and Utilization:

- *Before plugging the soldering iron into a power connection, using the needle nose pliers, check that the soldering iron's tip nut is tight. If it is loose, the connection will be poor, and the iron may not heat up properly. The soldering iron must be cool when checking and tightening the nut to avoid injury.*
- Assemble the soldering iron stand/holder.
- Make sure the sponge is damp (barely wet) and not soaking wet. Touching the hot tip to a sponge that is too wet can cool the tip down too quickly and cause thermal shock to the tip, decreasing the tool's longevity. Other soldering iron tip cleaners, such as coiled soft metal wire, may also be used.
- Place the soldering iron in the stand.
- Plug the soldering iron power cord into a power receptacle and pre-heat the iron. Standard soldering irons may take 2 to 3 minutes to heat fully.
- Once the iron is heated, run the tip across the damp sponge a few times, being careful to keep your fingers away while holding the sponge in place. (Figure 2)
- Pull at least 3" of solder from the tube.
- Hold the solder, not the tube, between your fingers for greater control. Remember to keep your fingers away from the hot tip of the soldering iron.



Figure 2

- ❑ Hold the soldering iron like a pen and rest your arm on a hard surface. This will provide greater precision and stability.
- ❑ Tin the tip of the soldering iron by holding the solder to the tip of the hot iron, coating the tip with solder until it is shiny. (Figure 3)
- ❑ Wipe the tip again on the dampened sponge to remove excess solder.
- ❑ Hold the solder to the tip again until a drop of melted solder forms on the tip. Besides protecting the tip from oxidation, applying a little solder to the tip of the soldering iron helps to transfer heat to the junction being soldered.
- ❑ Hold the soldering iron at a low angle to the PCB with the solder puddle on the tip touching the solder pad and the terminal of the component being soldered. (Figure 4)
- ❑ Hold the soldering iron in place for 2-3 seconds to heat the connection to solder-melting temperature. Apply heat with the *side* of the soldering iron tip, *not the point*, which has very small surface area and cannot conduct as much heat.

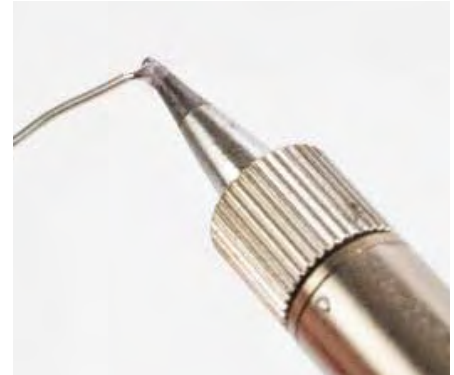

Figure 3

- ❑ From the opposite side of the terminal, hold the solder at a slight angle to the PCB solder pad to be soldered, and feed solder on until it flows over the connection. Holding the solder *at a slight angle and not perpendicular to the PCB* will prevent solder flowing through the hole in the solder pad.
- ❑ Remove the solder.
- ❑ Hold the soldering iron on the connection for just a second or so longer to make sure that all solder has attained its full melting temperature, then remove the soldering iron.

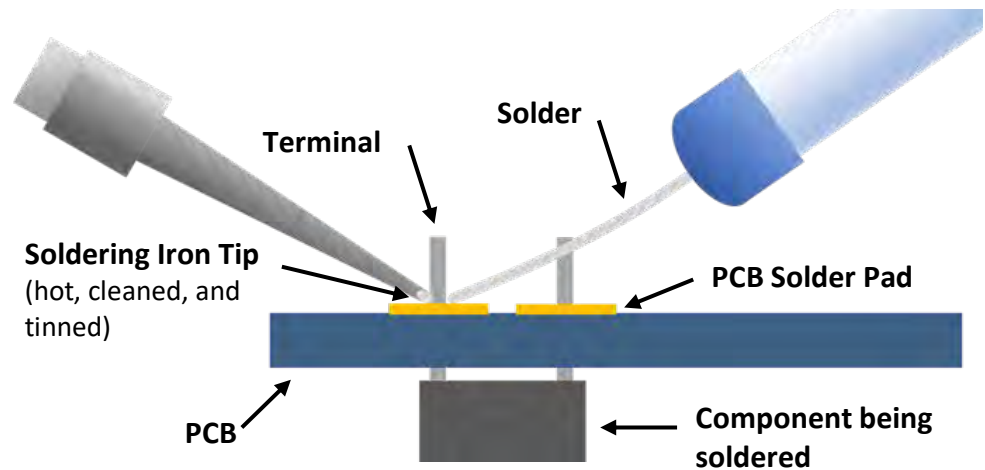

Figure 4

Do not touch or otherwise disturb the hot connection for several seconds while it cools and hardens.

A good solder joint will be triangular shaped from the side view (flat on the bottom, pointed on the top) and will not bridge (touch) another solder joint. (Figure 5)



Figure 5



- ❑ After soldering, quickly clean (wipe on the damp sponge) and re-tin (apply some fresh solder) the tip before EVERY soldering step. This is essential to keep the tip in good shape for soldering the next connection. Keep the tip of the iron shiny and tinned at all times. Do not use a file or sandpaper to clean an oxidized tip as this will remove its plating.
- ❑ Prior to turning off the soldering iron, tin the tip. This will help to maintain the soldering iron and keep it in good working order for future use.

## De-Soldering Pump

The de-soldering pump is used in conjunction with the soldering iron to remove solder joints when replacing broken components or troubleshooting an electrical circuit that is not working correctly. (Figure 6)



Figure 6

### Safety Information:

- Safety glasses should always be worn when using this tool.
- Follow safety guidelines for the soldering iron.

### De-Soldering Pump Usage:

- ❑ Press down on the plunger of the de-soldering pump until it clicks in place.
- ❑ Melt a small drop of solder onto the iron's tip.
- ❑ Touch the tip of the iron to the connection that needs to be repaired until the solder begins to melt.
- ❑ Place the tip of the de-soldering pump as close as possible against the melted connection. (Figure 7)
- ❑ Press the button while keeping the tip of the pump in place, causing the plunger to retract and remove the melted solder. (Figure 8)
- ❑ Repeat until all solder is removed.
- ❑ Re-solder as needed.
- ❑ De-soldering is easier if you have a helper – one person to hold the soldering iron and one to hold the de-soldering pump.

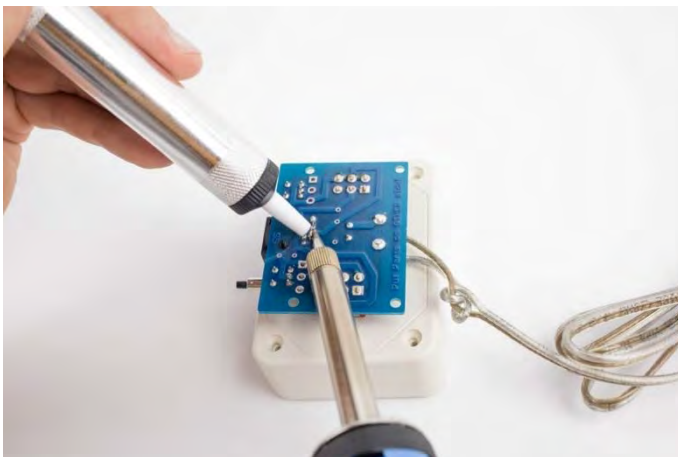

Figure 7

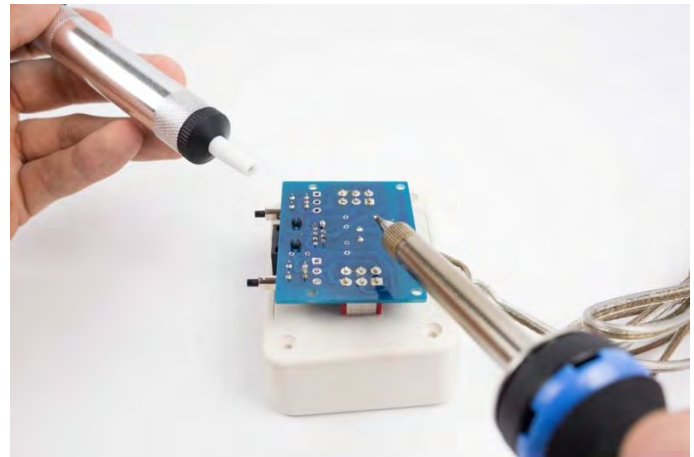

Figure 8

## Table Vise

A table vise has two parallel jaws (one fixed and one movable) and is used for securely holding a workpiece stationary when drilling, filing, sawing, gluing, or hammering. (Figure 9)

### Safety Information:

- Wearing close-toed shoes is recommended anytime the table vise is used.

### Table Vise Usage:

- To mount the table vise, loosen the clamping knob at the bottom until the opening between the table clamp and the rubber surface grip is large enough to fit over the edge of your workstation.
- Place the table vise over the edge of your workstation and tighten the clamping knob, making sure that the table vise is securely attached.
- The table vise is designed to swivel to allow the jaws to adjust to horizontal, vertical, and angled positions. To adjust, loosen the swivel locking handle, swivel the vise to the desired position and re-tighten the swivel locking handle.

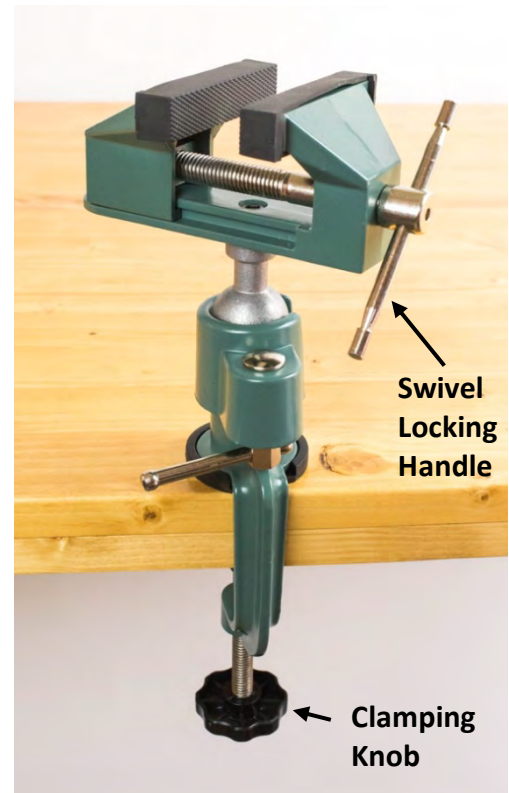

Figure 9

## PVC Pipe Cutter

A PVC pipe cutter uses a ratchet mechanism that cuts through the pipe little by little each time the handles are fully squeezed, resulting in a clean, straight cut. (Figure 10)

### Safety Information:

- Safety glasses should always be worn when using this tool.
- Always keep hands and fingers away from the sharp blade.
- Do not try to catch pipe pieces as they are cut. Let them fall and pick them up later.
- Do not pass the pipe cutter from user to user. Place the tool on the workstation and allow the next user to pick it up.
- Store the tool in its closed position and secure the handles with the latch at the bottom of the tool.
- Do not attempt to take the tool apart. The blade can spring out and cause injury.



Figure 10

### PVC Pipe Cutter Usage:

- Carefully open the pipe cutter by pulling the handles apart until they are fully extended. The tool may be a little harder to open during its first use. Pull carefully and firmly. (Figure 11)
- Fully squeezing and releasing (ratcheting) the handles of the cutter will cause the blade to advance. Work slowly so that the blade has time to move through the material. Do not twist the tool. The blades can be damaged if the tool is used to cut anything except PVC pipe, or if used incorrectly.



Figure 11

## Drill and Drill Bits

A drill is used to bore holes into a variety of materials (such as wood or plastics), drive and remove screws and other small fasteners, and drill pilot holes. (Figure 12)

### Safety Information:

- Safety glasses should always be worn when using this tool.
- The drill rotates at high speeds. It can strip objects out of your grasp. This can result in injury to the user or others in the workspace.
- Before using the drill, secure any loose clothing, remove any dangling jewelry (necklaces, earrings, bracelets, etc.), and tie back long hair.
- Never try to hold the PVC pipe, fittings, or other items by hand when drilling.
- Wearing close-toed shoes is recommended when drilling.
- Never place a body part in the path of a drill bit. Always think about what is behind the object being drilled, particularly body parts, tabletops, or the table vise.
- Never use the trigger lock feature on the drill. If the drill is dropped when the trigger lock feature is on, the bit will continue to spin which can result in injury.
- Do not pass the drill from user to user. Place the tool on the workstation and allow the next user to pick it up.
- The drill should always be unplugged when installing or removing drill bits to avoid accidentally pulling the trigger during installation, which can cause injury.
- Drill bits are sharp! Grip the drill bits loosely when installing and removing them from the drill, and do not run your fingers along their sharp edges.



Figure 12

### Drill and Drill Bits Usage:

- Install the bit by loosening the locking ring on the drill and inserting the smooth end of the bit into the chuck. (Figure 13)
- Re-tighten the locking ring once the bit is in place.

Make sure that the bit is inserted straight and fits tightly into the chuck before use. If the bit wobbles or otherwise appears loose, unplug the drill, remove and reposition the bit, and recheck.

The tighter the trigger is pulled, the faster the drill will go. Full speed is too fast for drilling the pipes and other items when building the SeaPerch ROV. Practice first to find the proper speed.



Figure 13

## Digital Multimeter

A digital multimeter is an electronic test meter used to measure and digitally display values for voltage, amperage, and resistance in electronic circuits and to test electronic components. (Figure 14)

The multimeter that comes in the SeaPerch Tool Kit has the following capabilities:

- Measure direct current voltage (DCV)
- Measure resistance (Ohms designated by the Greek symbol  $\Omega$ )
- Test continuity
- Measure alternating current voltage (ACV)\*
- Measure direct current amperage (DCA)\*
- Measure the forward drop voltage of diodes\*
- Test transistors\*



Figure 14

\*Function not used in SeaPerch ROV testing.

A full guide to digital multimeter usage is beyond the scope of this manual. *This manual will only focus on the settings, measurements, and tests used during the SeaPerch ROV testing.*

### Safety Information:

- Please read the safety information in the user manual supplied with the multimeter. Improper use of the multimeter can lead to electrocution.
- Always hold the probes in separate hands and hold them by the insulated handles.

- Do not touch the metal ends of the probes.
- Do not use the meter if the meter or the test leads look damaged, or if you suspect that the meter is not operating properly.
- Turn off the power to the circuit under test before cutting, unsoldering, or breaking the circuit. Small amounts of current can be dangerous.
- When using the test lead, keep your fingers behind the guards on the test lead.
- Disconnect the live test lead before disconnecting the common test lead.

### Digital Multimeter Usage:

- Remove the protective caps from the probe end and the connector end of the multimeter probe if they are installed.
- Insert the connector on the black probe cable into the COM connector socket of the multimeter.
- Insert the connector on the red probe cable into the V  $\Omega$  mA connector socket of the multimeter.

### Using the multimeter to test the Direct Current (DC) Voltage (V) of the SeaPerch ROV battery:

The battery supplied with the full SeaPerch ROV kit is a 12V DC battery. When fully charged, the battery voltage can measure 13 to 14 volts.

When measuring voltage, always set the function/rotary switch to a value greater than the expected voltage being measured.

- Set the multimeter's function/rotary switch to 20 in the DCV section. (Figure 15)
- Touch the red probe end to the positive battery terminal (red marking and + symbol)
- Touch the black probe end to the negative battery terminal (black terminal with the – symbol)

A multimeter display of 12.00 or more indicates that the battery has a sufficient charge to operate the SeaPerch ROV.

A multimeter display of less than 12.00 indicates that the battery needs to be charged before use. If this is the case, refer to the “12 Volt Lead Acid Battery Usage and Safety” section.



Figure 15

### Using the multimeter to test the controller’s fuse for continuity

The fuse will be tested for continuity which is the continuous connection or pathway in an electric circuit. The test will indicate a closed circuit (continuity) if the fuse is good or it will show an open circuit (no continuity) if the fuse has blown.

- Connect the probes to the multimeter and set the multimeter’s function/rotary switch to the continuity test selection. (Figure 16)
- Touch the two probe ends together and make sure that the meter beeps and the display goes to zero or close to zero. This indicates a continuous circuit.
- Touch one probe end to one terminal of the fuse and touch the other probe end to the other terminal of the fuse. It does not matter which probe end is touching which fuse terminal.

The meter should beep, and the display should go to zero or close to zero. This indicates a continuity in the fuse and indicates that the fuse is good.

If the meter does not indicate continuity, make sure the metal probe ends are firmly touching the fuse terminals. If an open circuit (no continuity) is still indicated the fuse must be replaced.

If the fuse was blown while in use in a controller, the root cause of the overcurrent should be fixed first. Refer to Section 1 - Controller Assembly.



Figure 16

## Screwdriver

A screwdriver is a hand tool used to insert or remove screws. (Figure 17)

### Safety Information and Usage:

- The screwdriver should not be used to pry or make holes.
- Care should be exercised while inserting or removing screws to avoid having the screwdriver tip slip off the screw head and poke into a body part or damage a tabletop.
- The size of the screwdriver tip should be appropriate for the size of the screw.



Figure 17

## Diagonal Cutting Pliers

Diagonal cutting pliers are used to cut wires, small pins, and plastics. Angled cutting blades allow objects to be cut flush with a surface without the tool's handles getting in the way. (Figure 18)

### Safety Information and Usage:

- Nothing should be cut with the diagonal cutting pliers other than copper wire or plastic cable ties.
- Never use this tool on pipe or metal fasteners, which could ruin the cutting edges.
- Be careful when handling to avoid being cut or poked by the tool's sharp cutting edges or tips.



Figure 18

## Wire Stripper

The wire stripper is a hand tool used to strip the electrical insulation from electric wires. (Figure 19)

### Safety Information:

- This tool presents a pinch hazard. Avoid contact with the tool's jaws and stripping slots.

### Wire Stripper Usage:

- Insert about ½" wire into the appropriate gauge mark on the wire stripper.
- Grasp the handles of the wire stripper firmly in one hand and gently rotate the longer end of the wire in a circular motion with the other hand, making a score line/cut through the wire's outer insulation. (Figure 20)
- Pull wire stripper at a slight angle, making sure to only remove the outer insulation and none of the individual wires.



Figure 19

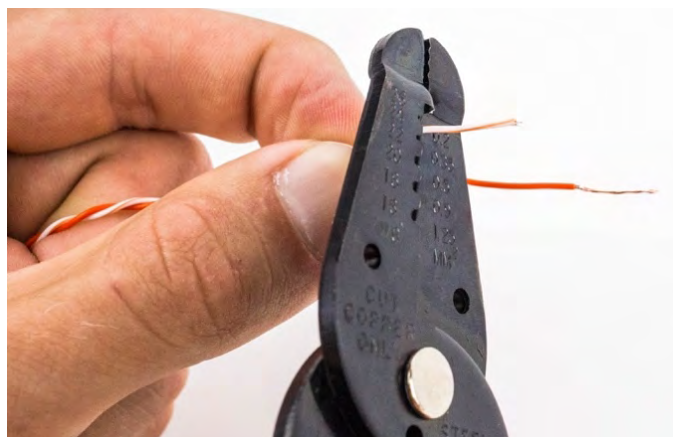

Figure 20

## Needle Nose Pliers

Needle nose pliers are used to bend or grip small-gauge wires or other objects that are too small to hold with your fingers or where regular pliers would be too large. (Figure 21)

### Safety:

- This tool presents a pinch hazard. Avoid contact with the tool's jaws.
- This tool should not be used on live electrical wires.



Figure 21

## 12 Volt Lead Acid Battery

The lead acid battery is a type of rechargeable battery and is the power source for the SeaPerch ROV. (Figure 22) Lead acid batteries contain corrosive chemicals and can cause burns of eyes, skin, and mucous membranes. Lead acid batteries must be stored, used, and maintained in accordance with manufacturer guidelines.

### Safety Information:

- Understand all safety procedures before charging or using batteries.
- Wear eye protection when near a charging battery.
- Wearing closed-toe shoes is recommended when using the batteries.
- Charge in a well-ventilated space at temperatures between 50°F and 86°F (10°C and 30°C).
- Monitor the battery while charging and do not leave unattended.
- Examine the battery for damage or leaking before each use. If any damage or leaking is observed, do not plug in or use.
- Dispose of the lead acid battery in accordance with environmental waste regulations in your area.
- 12-V lead acid batteries are heavy. Being pulled from a tabletop can cause injury to users in the workspace or may damage the battery. Consider placing it on the floor instead of a tabletop.
- Keep the battery out of direct sunlight.
- Although the battery can be used quite safely when it is connected properly to the ROV, it can be damaged, cause wires to melt, or even start a fire if its positive and negative terminals are connected directly together. Never connect anything between the battery terminals except an appropriate electrical load such as the ROV circuitry, through its power cord (with a fuse in the circuit).
- Keep the battery terminals covered and away from all wires and metal objects and tools when not in use. The plastic covers for the terminals may have been dislodged during shipping of the ROV kit; you may find them loose in the bottom of the kit box or you can use electrical tape.
- Do not connect the ROV circuitry or components to the battery until instructed to do so.
- Do not touch both the positive and negative terminals of a battery with your hands or touch a battery terminal with one hand and part of the circuitry with the other.



Figure 22



- Make sure that all switches are in their off positions while connecting or disconnecting the battery and connect just one power wire at a time.

**Battery Usage:**

- The battery should be fully charged before use. A full charge should last at least two hours. To charge the battery, connect the red clip on the battery charger to the positive battery terminal (the red marking and + symbol).
- Connect the black clip on the battery charger to the negative battery terminal (the black terminal with the – symbol).
- Carefully plug the charger into an electrical outlet.
- Re-charge the battery after each use. Lead acid batteries will last much longer if they are stored charged.
- Disconnect the battery from the charger once fully charged. If the battery is left connected to the charger, the battery will be overcharged which can cause damage.

**Notes**

---

---

---

---

---

---

---

---

---

---

---

---

---

---

---

---

---

---

---

---

---

---

---

# SeaPerch Build Manual

## Notes

---



---



---



---



---



---



---



---



---



---



---



---



---



---



---



---



---



---



---



---



---



---



---



---



---



---



---



---



---



---



---



---



---



---



---



---



---



---



---



---



---



---



---



---



---



---

# SeaPerch Build Manual

## Section 1 Controller Assembly



### SECTION OBJECTIVE

In this section, you will mount and solder electrical components on a printed circuit board (PCB), mount the circuit board in the plastic control box, assemble and connect the power cord, and test the electrical system.

**Completion Estimate:** 4 hours



Figure 1

## Tools Needed



Figure 2

1. Solder
2. Soldering Iron
3. De-Soldering Pump
4. Digital Multimeter
5. Needle Nose Pliers
6. Diagonal Cutting Pliers
7. #2 Phillips Screwdriver
8. Scissors
9. Ruler
10. Safety Glasses (1 per student & mentor)
11. Wire Stripper (18 - 26 AWG Size)
12. Soldering Stand and Damp Sponge

**Optional:** Electrical, Painter's, or scotch tape

## Parts and Other Materials

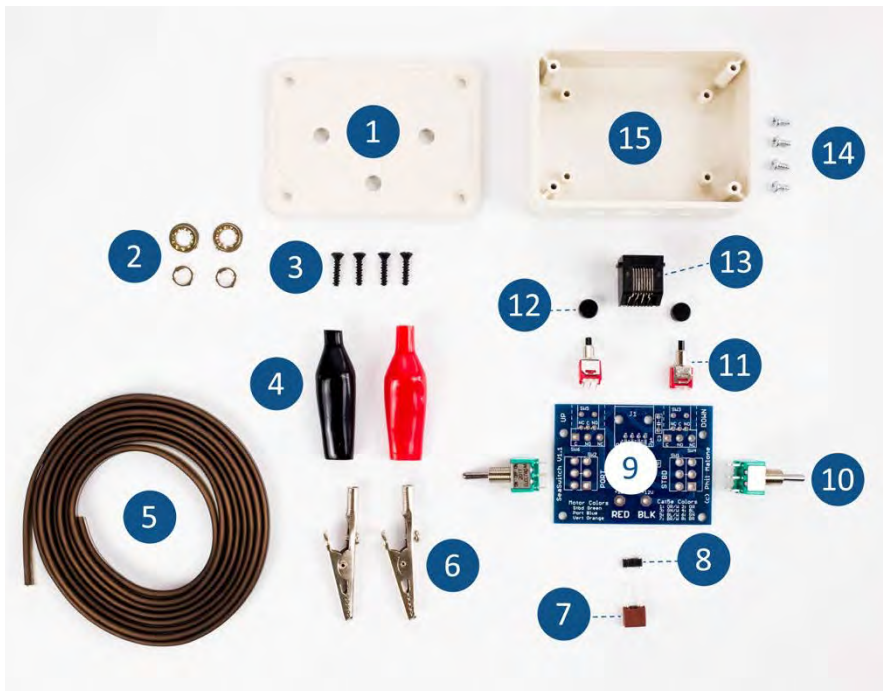

Figure 3

1. Control Box Lid
2. Toggle Switch Nuts and Washers
3. 4x Black Screws
4. 2x Alligator Clip Insulators
5. 18 AWG Wire
6. 2x Alligator Clips
7. Fuse
8. Fuse Holder
9. Printed Circuit Board (PCB)
10. 2x Toggle Switches
11. 2x Pushbutton Switches
12. 2x Pushbutton Switch Caps
13. RJ45 Connector Jack
14. 4x Silver Screws
15. Control Box Enclosure

### Task 1.1 – Preparing the Printed Circuit Board (PCB) Components

- Inspect each component and carefully straighten any bent terminals with the needle nose pliers.
- Place the eight small screws (4 silver, 4 black) in a safe place such as in the control box to prevent them from being misplaced. (Figure 4)
- Locate the two **toggle switches**. If they have nuts and/or washers on their threaded mounting shafts, remove all nuts and the washers. Use pliers to loosen the nuts, if needed. Save the nuts to help secure the switches while soldering later in this section. (Note: The nuts may not be installed on the toggle switches and may be loose in the controller enclosure with the other parts.)



Figure 4

The components will be installed and soldered in order according to their size, smallest first. Refer to Table 1 and Figure 5 during assembly.

**DO NOT INSTALL COMPONENTS UNTIL CALLED FOR IN THE INSTRUCTIONS.**

Order	Component	PCB Location
1	Fuse Holder	F1
2	Pushbutton Switch	SW3
2	Pushbutton Switch	SW5
3	Toggle Switch	SW1
3	Toggle Switch	SW2
4	RJ45 Connector Jack	J1

Table 1

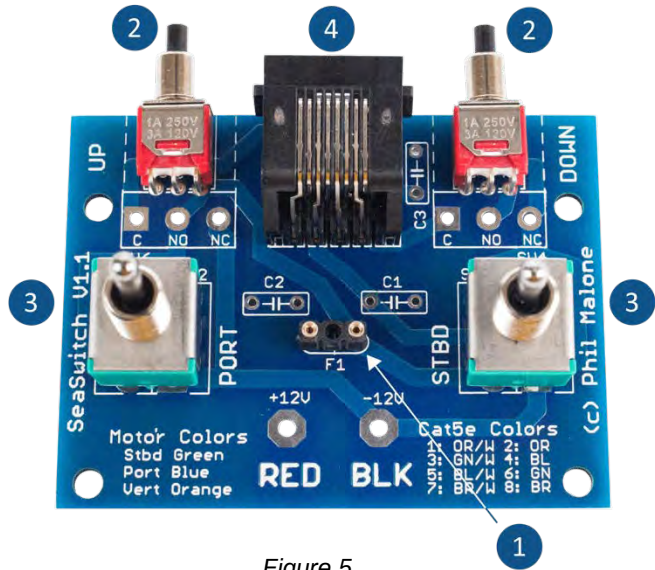

Figure 5



## LEARN MORE ABOUT PRINTED CIRCUIT BOARDS

A printed circuit board (PCB) is a piece of fiberglass with copper plating on both sides. Through a photographic and chemical etching process, some of the copper is removed, leaving traces (lines) and silver pads (circular, square or octagonal shaped) where components are affixed.

“Put parts on OTHER side” is printed on the back of the PCB (the *solder side*). (Figure 6)

Components are inserted through the side of the PCB with the white lettering (the *component side*). (Figure 7)

During this unit, the components’ short, rigid pins that are inserted through the holes on the component side of the PCB are referred to as *terminals*.

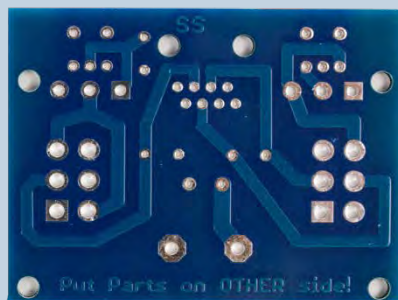

Figure 6

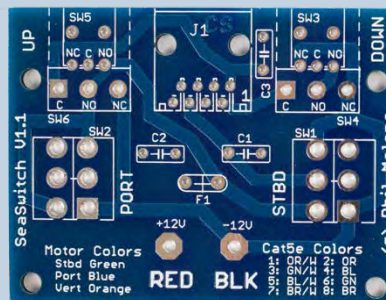

Figure 7

## Task 1.2 – Installing the Fuse Holder

Before beginning, refer to the **Tool Usage, Skills, and Safety** Section for more information about safely using the soldering iron and the de-soldering pump.

**SAFETY**



It's time to put on your safety glasses.

- ❑ Locate the **fuse holder**. Make sure it is the fuse holder (black in color) and NOT the fuse (red in color)!
- ❑ Place its two terminals through the location labeled F1 on the component side of the PCB. (Figure 8)

The fuse holder provides a convenient means of attaching or removing the fuse to a PCB.

A blown fuse can easily be replaced when inserted in a fuse holder and eliminates the need for de-soldering and re-soldering.

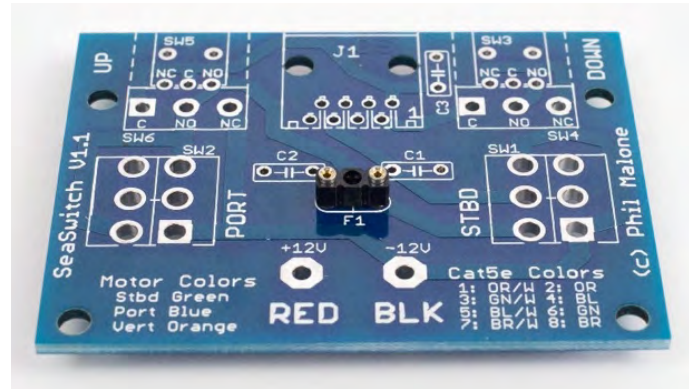

Figure 8

**Do not insert the fuse until later in this section.** If inserted now it will be damaged by the heat of soldering the other components and the power cable to the PCB.

**TIP**



Use a small piece of tape to hold the fuse holder in place. (Figure 9)

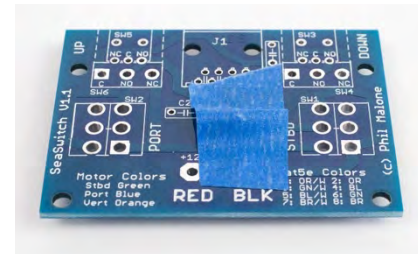

Figure 9

- ❑ Flip the board over and place it on the workstation.
- ❑ Hold the soldering iron tip touching one of the pads and a terminal for 2-3 seconds to heat the connection.
- ❑ From the opposite side of the terminal, hold the solder at a low angle to the solder pad and make sure it is touching the pad and terminal (not the soldering iron tip). Holding the solder at a low angle to the pad will prevent solder going through the hole and onto the other side of the board. (Figure 10)

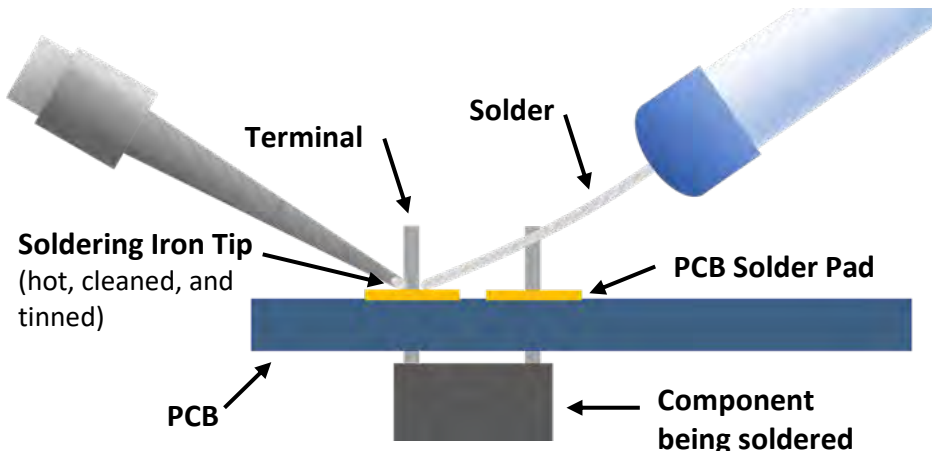

Figure 10

- When the solder begins to melt, feed solder by pushing it until it flows over the connection. This will take about 2-3 seconds.
- Remove the solder first, and then remove the soldering iron tip.



**TIP**

Soldering Order: Iron on → solder on → solder off → iron off

Do not disturb the connection for several seconds while it cools and hardens. The components will remain hot for a couple of minutes.

**TIP**

A good solder joint will be triangular-shaped (flat on the bottom, pointed on the top). Refer to the Soldering Iron section under *Tool Usage, Skills, and Safety*.



If solder will not stick to the tip of the iron, the tip needs to be cleaned. Clean the soldering iron tip before EVERY soldering step and then touch solder to the tip of the soldering iron to tin it before starting to solder the next component.

- Inspect for solder bridges or connections that do not seem to have enough solder. Repair and re-solder as needed.

## Task 1.3 – Installing the Pushbutton Switches

- Locate the two pushbutton switches.

The pushbutton switches operate the vertical thruster so the ROV can dive and surface. One switch turns the thruster for clockwise movement and the other switch turns the thruster for counterclockwise movement.

- Place the switches in the SW3 and SW5 locations on the component side of the PCB.. (Figure 11 & 12)  
Switches are identical and may be placed in either location.

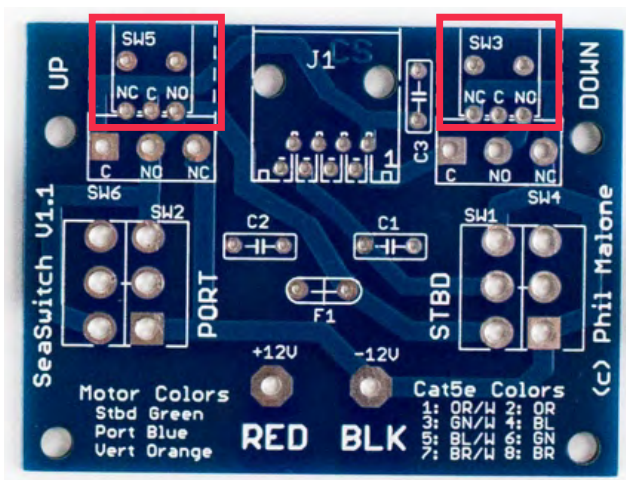

Figure 11

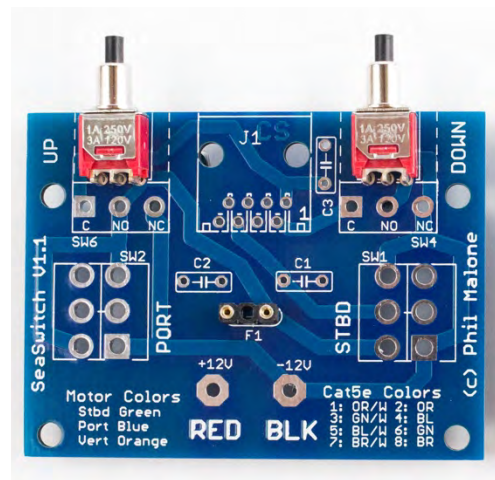

Figure 12

Make sure that the switches are flush against the PCB before soldering so that it will fit properly in the enclosure box later in this section. (Figure 13)

- ❑ While holding the switches in place with a piece of tape, flip the PCB over and place it on the workstation.
- ❑ Hold the soldering iron tip parallel to one of the pads and a terminal for 2-3 seconds to heat the connection.
- ❑ From the opposite side of the iron's tip, feed solder until it flows over the connection. This will take about 2-3 seconds.
- ❑ Remove the solder and then remove the soldering iron tip.

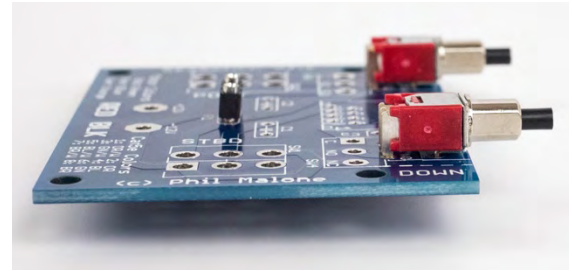

Figure 13

Do not disturb or touch the connection for several seconds while it cools and hardens.

To avoid overheating and damaging these components, wait a few seconds between connections, or alternate between the two switches, soldering a terminal on each switch at a time.

- ❑ Continue until all 10 terminals are soldered.
- ❑ Inspect for bridges between the connections. Repair as necessary.

## Task 1.4 – Installing the Toggle Switches

- ❑ Locate the two **toggle switches** and the control box lid.

The toggle switches control the left and right thrusters and provide forward, reverse, and turning movement of the ROV.

- ❑ Place the switches in the SW1 and SW2 locations on the component side of the PCB. (Figure 14 & 15)

They will fit on the PCB one of two ways; it does not matter which way they are inserted as long as the terminals protrude through to the solder side of the PCB. The switches may not fit snugly.

Keep these switches perpendicular to the board to ensure a proper fit when installed in the control box enclosure later in this section.

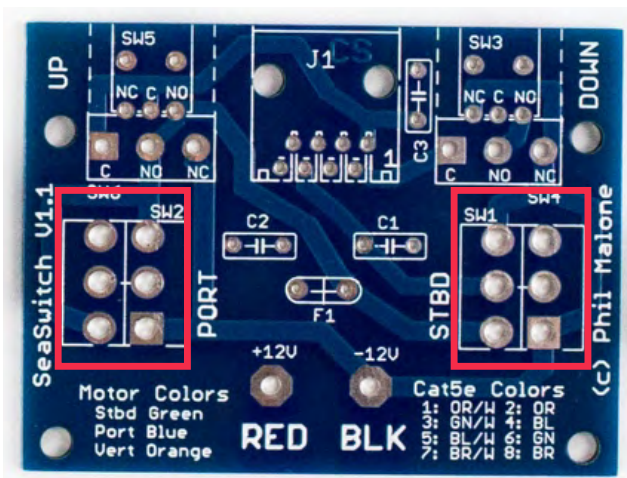

Figure 14

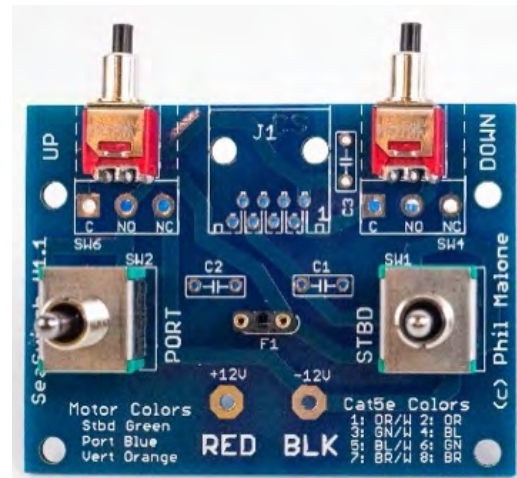

Figure 15



The switches can be held in place while soldering by using the control box enclosure and lid. Put the toggle handles through the two center holes in the control box lid. (Figure 16)

- While holding the PCB against the back of the switches, turn the assembly over and place it across the open top of the control box. (Figure 17)

The toggle switch terminals are much larger than those on the fuse holder and pushbutton switches. Therefore, it takes more time with the iron in place and requires more solder to form a good connection.

- Hold the soldering iron tip parallel to one of the pads and a terminal for 2-5 seconds to heat the connection.
- From the opposite side of the iron's tip, feed solder on until it flows over the connection. This will take about 2-5 seconds.



#### TIP

To solder these components, you will need to clean and tin the soldering iron's tip between each connection.

To avoid overheating and damaging these components, alternate between the two switches, soldering a terminal on each switch at a time.

- Continue until all 12 terminals are soldered.

Do not disturb or touch the connections for several seconds while they cool and harden. The toggle switches could get hot enough to burn skin during soldering so make sure all components have cooled before touching them.

- Inspect for solder bridges or connections that do not seem to have enough solder. Repair and re-solder as needed.



Figure 16

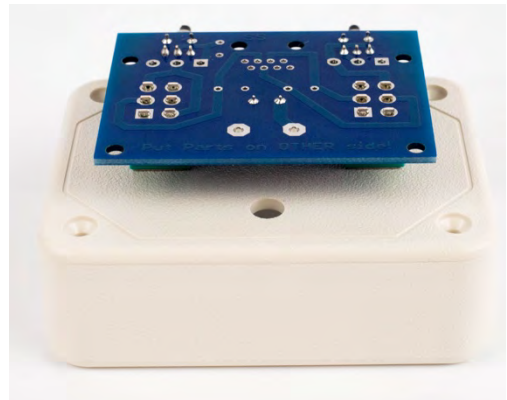

Figure 17

## Task 1.5 – Installing the RJ45 Connector Jack

- Locate the **RJ45** connector jack.

The ROV's tether cable connector is plugged into the RJ45 connector jack to provide power to the thrusters.

- Insert the RJ45 connector jack through location J1 on the component side of the PCB (Figure 18 & 19 on next page). Press firmly on the jack to snap it into place until it is flush with the board.

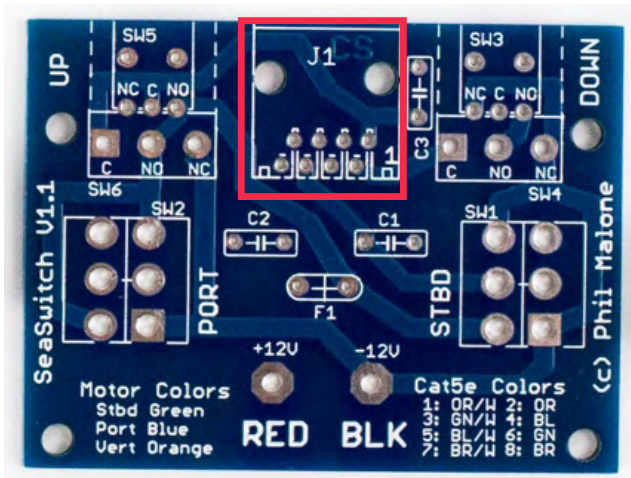

Figure 18

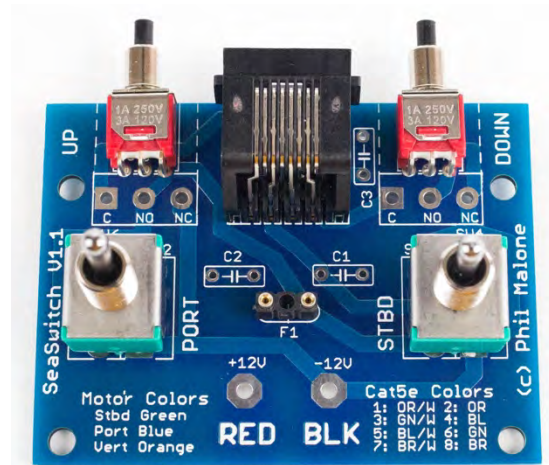

Figure 19

- ❑ Turn the assembly over and place it across the open top of the control box. (Figure 20)
- ❑ Solder the eight terminals. To avoid bridges between these closely spaced connections, place the soldering tip on the outside of the terminal rows, not between the terminals, and do not use too much solder. (Figure 20)

Do not disturb or touch the connections for several seconds while they cool and harden.

- ❑ Re-examine all solder connections and repair and re-solder as needed.

**Do not insert the fuse yet.** It will be damaged by the heat used to solder the power cord to the PCB in the next procedure.

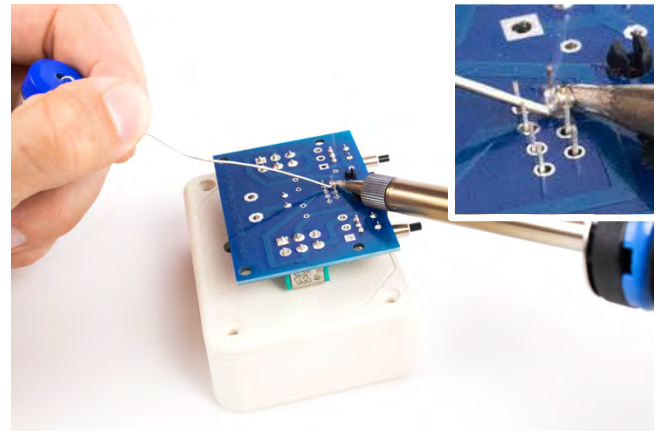

Figure 20

## Task 1.6 – Assembling the Power Cord

Refer to the **Tool Usage, Skills, and Safety Section** for more information about safely using the wire stripper, diagonal cutting pliers, and soldering iron.

### SAFETY



In case you've taken off your safety glasses (tsk, tsk), it's time to put them back on.

- ❑ Using diagonal cutting pliers, snip about 1" of the thin web of plastic/insulation between the two wires (copper and silver) on one end of the 18-gauge wire. Be careful not to nick the insulation on either of the individual conductors. (Figure 21)



Figure 21

- ❑ Pull the two insulated wires 3-4" apart. (Figure 22)
- ❑ Pass the wires through the center hole in the control box enclosure lid, from the top side.
- ❑ Tie a strain relief knot in the two wires about 1" from the ends, on the underside of the lid.
- ❑ Cut the ends of the two insulated wires to the same length.
- ❑ Insert about 1/2" of the wire into the 18-gauge notch on the wire stripper and strip off the outer insulation. (Figure 23)



Figure 22

Note that the wires on one side are copper colored and the wires in the other are silver colored. For this project, we will call the copper side the positive (+) wire, and the silver side the negative (-) wire.

- ❑ Twist the strands on each of the ends (individually, not all together) tightly to prevent fraying and breaking. (Figure 24)
- ❑ Insert the copper-colored wire into the hole labeled +12V RED on the PCB from the component side. (Figure 25)
- ❑ Insert the silver-colored wire into the hole labeled -12V BLK on the PCB from the component side. (Figure 25)
- ❑ Push the wires through until the insulation touches the PCB.
- ❑ Bend the wires slightly to help hold them in place.
- ❑ Position the circuit with the toggle switch handles inserted in the control box enclosure lid. Get ready to solder. (Figure 26)



Figure 23

The PCB can be taped on both sides to the lid to hold it securely while soldering or the toggle switch nuts can be used to hold the assembly more rigidly.



Figure 24

**TIP**



Soldering wires requires more time with the iron on the pad and more solder than needed for the component terminals soldered earlier in this section.

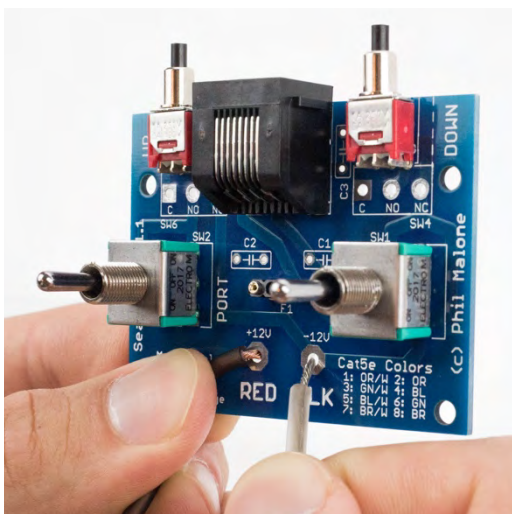

Figure 25

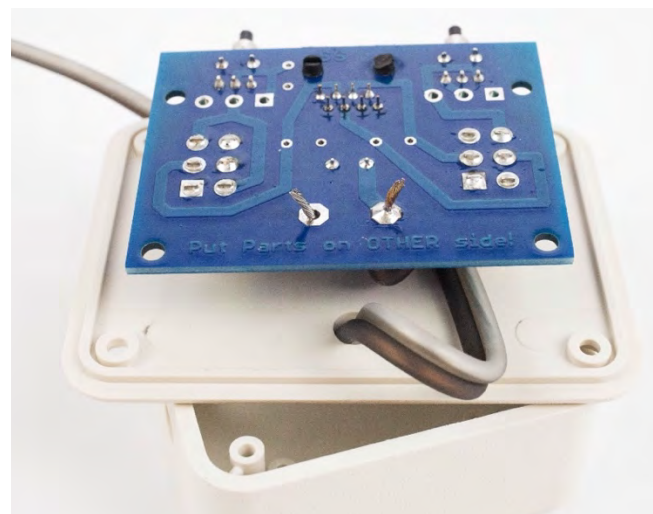

Figure 26

- ❑ Position the soldering iron tip so it is touching the PCB pad and the wire.
- ❑ Hold the soldering iron tip on the pads and the wire strands for 5-10 seconds to heat the connection.
- ❑ Start applying solder to the side of the wire opposite the soldering iron. Continuously feed the solder to fill the hole and pad and to cover part of the wire with solder. This should not take more than 5 seconds to avoid overheating the PCB. This will ensure a good solder joint.
- ❑ Remove the solder and then remove the soldering iron tip from the solder joint.
- ❑ The solder joint should look similar to the wire on the right side in Figure 27.
- ❑ Repeat for the other wire.
- ❑ Inspect for solder connections that do not seem to have enough solder.
- ❑ Once cooled, tug gently on the wires from the knot to ensure they are firmly attached to the PCB.
- ❑ Repair and re-solder as needed.



Figure 27

This completes the soldering for the controller.

- ❑ Unplug the soldering iron and allow it (and the stand) to cool completely before handling.
- ❑ Trim the excess wire with the diagonal cutting pliers, being careful not to cut too close to the PCB and the solder joint. Hold one hand over the wires while trimming or point the wire ends toward the worksurface to prevent the wires from becoming airborne. (Figure 28)
- ❑ On the **other end of the 18-gauge wire**, using diagonal cutting pliers, snip about 1" of the thin web of plastic/insulation between the two wires. Be careful not to nick the insulation on either of the individual conductors. (Refer back to Figure 21, if necessary.)
- ❑ Pull the two insulated wires 6" apart. (Refer back to Figure 22, if necessary.)
- ❑ Strip 1" of insulation from both wires. (Refer back to Figure 23, if necessary.)
- ❑ Twist the strands on each of the ends (individually, not all together) tightly to prevent fraying and breaking. (Refer back to Figure 24, if necessary.)

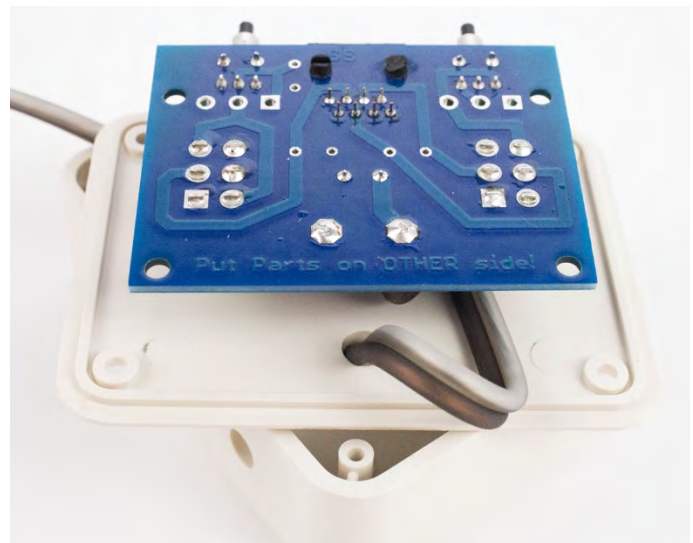

Figure 28

- ❑ Slide the red alligator clip insulator (small end first) onto the positive (copper-colored) wire. Make sure that its large end is nearest the end of the stripped wire. (Figure 29)
- ❑ Slide the black alligator clip insulator (small end first) onto the negative (silver-colored) wire. Make sure that its large end is nearest the end of the stripped wire. (Figure 29)
- ❑ Loosen (do not remove) the screw on the alligator clip using the #2 Phillips screwdriver.
- ❑ Insert one of the twisted ends into the open, hollow end of an alligator clip until it comes through the slot on the top of the clip by the screw. (Figure 29). Needle nose pliers can be used to help pull the wires through.
- ❑ Re-twist the wires and wrap them tightly around the screw in a clockwise direction. Make sure the wire is on the left side of the screw. Continue wrapping until most of the wires are captured under the screw's head. Some of the individual wires may not be under the screw's head due to the size of the wires. This is okay for this application.
- ❑ Tighten the screw (Figure 30).



Figure 29



Figure 30

**TIP**



The ends of the wires could be soldered before inserting them in the alligator clip and wrapping them around the screw. Use needle nose pliers, if needed, to pull the wires through the alligator clip and to help wrap the wires around the screw as the solder will make the wire slightly harder to bend. Allow the wires to cool completely before handling.

- ❑ Repeat for the other wire.
- ❑ Clamp the alligator clip onto a pencil to hold it open.
- ❑ Slide the insulator over the alligator clip.
- ❑ Repeat to install the other alligator clip.

Finished results shown in Figure 31 (showing screw and wire) and Figure 32 (showing placement of insulator).



Figure 31

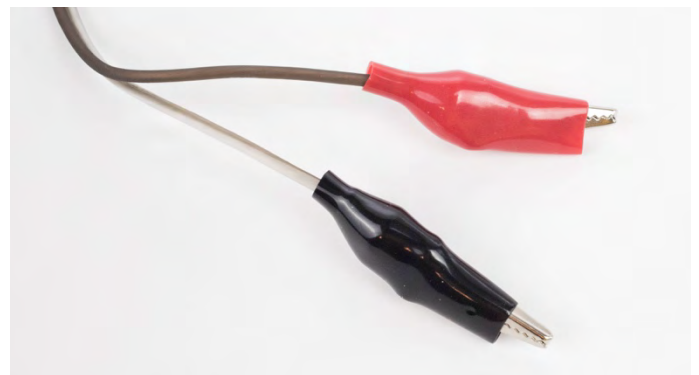

Figure 32

## Task 1.7 – Installing the Fuse

- Locate the fuse.
- Using the diagonal cutting pliers, trim both terminals on the fuse to about ¼". (Figure 33)
- Install the fuse into the fuse holder on the PCB. (Figure 34)



Figure 33

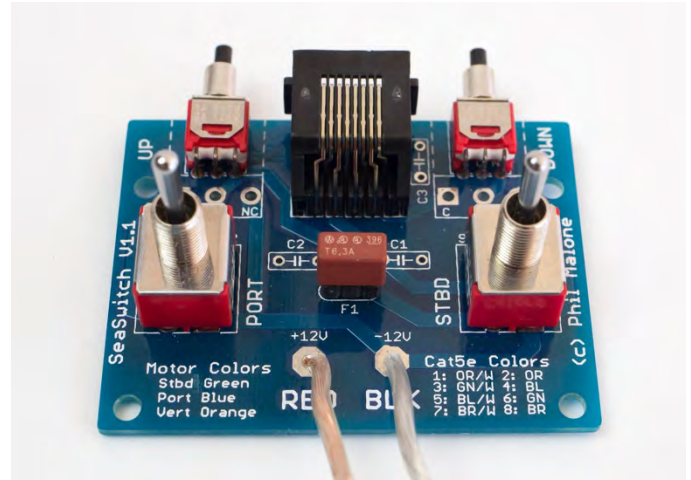

Figure 34



### LEARN MORE ABOUT FUSES

A fuse is an electrical circuit component that protects the circuit from excessive current and overload. An overload occurs when too much current passes through the system, producing heat that can melt components and cause a fire. Fuses are typically constructed of fine metal wires engineered to burn (or blow) if certain amperages in the circuit are exceeded.

## Task 1.8 – Testing the Electrical System

Refer to the **Tool Usage, Skills, and Safety Section** for more information about using the Digital Multimeter.

**DO NOT** connect the battery until the controller has passed all tests in this section. Connecting the battery to a faulty controller circuit could damage the controller or the battery.

**DO NOT** connect the tether cable to the controller until instructed to do so.



### LEARN MORE ABOUT SHORT CIRCUITS

A short circuit is a direct connection between two points in a circuit that aren't supposed to be directly connected. This occurs when there is a solder bridge or when there is a short in a switch or connector. A short circuit can cause circuit damage or overheating.

- ❑ Conduct one final inspection of the PCB for solder bridges or for connections that do not have enough solder. Repair as needed.
- ❑ Connect the probes to the digital multimeter.
- ❑ Set the dial on the digital multimeter to measure continuity as shown in the insert of Figure 35. If your multimeter does not have a continuity setting, set it to measure Ohms ( $\Omega$ ) using one of the lower Ohms settings such as 200 or 2000.

The multimeter should display a 1.

- ❑ Touch the probe ends together. The multimeter should beep, and the display should read zero or close to zero.
- ❑ Connect the alligator clips to the multimeter probes. *The colors do not matter, but it is good to get in the habit of connecting red to red, black to black.*

The multimeter should display a 1.

If the multimeter beeps or the display value changes, the circuit has a short and must be repaired before continuing. STOP and recheck for bridged connections.

- ❑ Activate each of the four switches one at a time. For the toggle switches, push the toggle lever forward and pull it backwards until it clicks to test each switch position. The multimeter should not beep, and the display should not change.

If the multimeter beeps or the display value changes, the circuit has a short and must be repaired before continuing. Stop and recheck the solder connections on the switch that indicated a short and assure that there are no bridged connections.

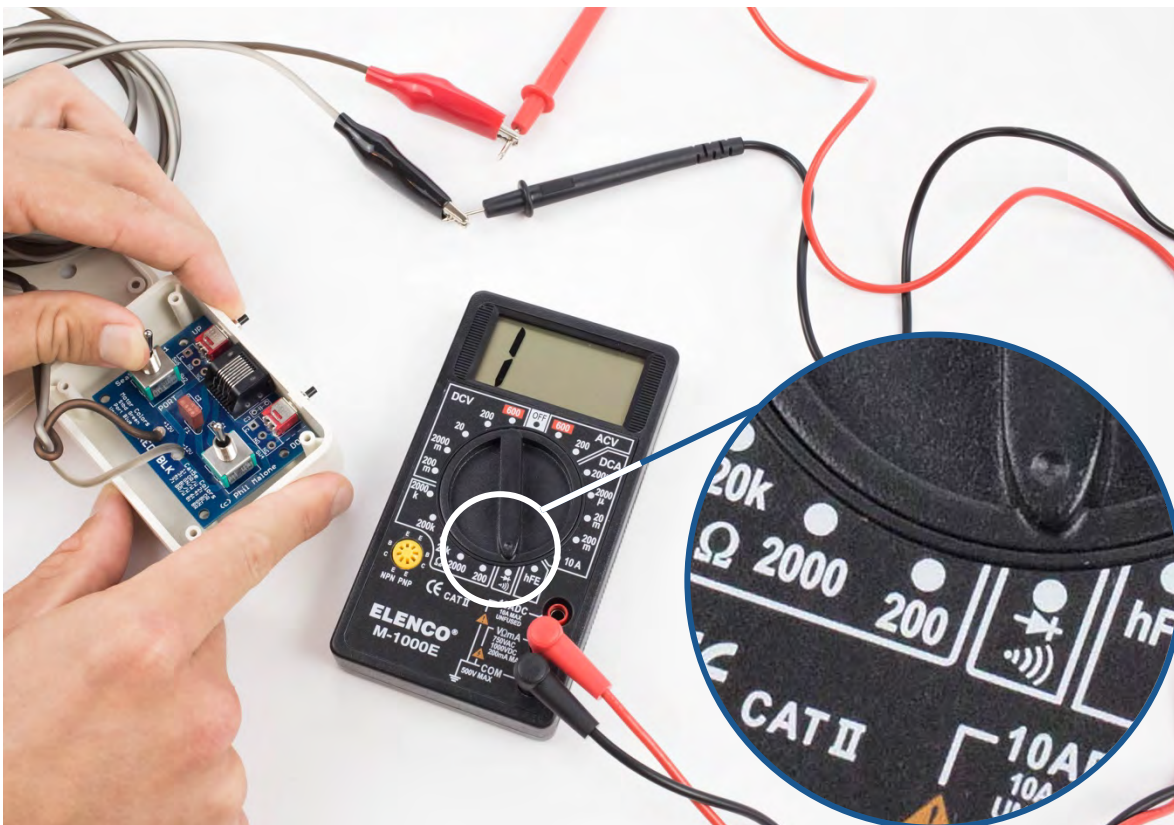

Figure 35

## Task 1.9 – Testing the Controller & Thruster System



### TIP

If the thruster assemblies have been completed, proceed with the steps below. If not, follow these steps once the thruster assemblies are constructed.

- ❑ Plug the tether cable connector into the controller's RJ45 connector jack. (Figure 36) The tether connector has a prong which must be oriented correctly to plug into the connector jack.

The multimeter should still be set to measure continuity and the alligator clips should still be connected to the probe ends of the multimeter. (Refer back to Figure 35, if necessary.)

- ❑ Activate each of the four switches one at a time. For the toggle switches, push the toggle lever forward and pull it backwards until it clicks to test each switch position.

The display should read a low value greater than zero and less than around 30. If the value is less than 10, the meter will beep; this is okay as it is an expected result.

If the displayed value is 0 this indicates a short in the tether cable or thruster being tested. Stop and resolve this short before connecting the battery and using the ROV.

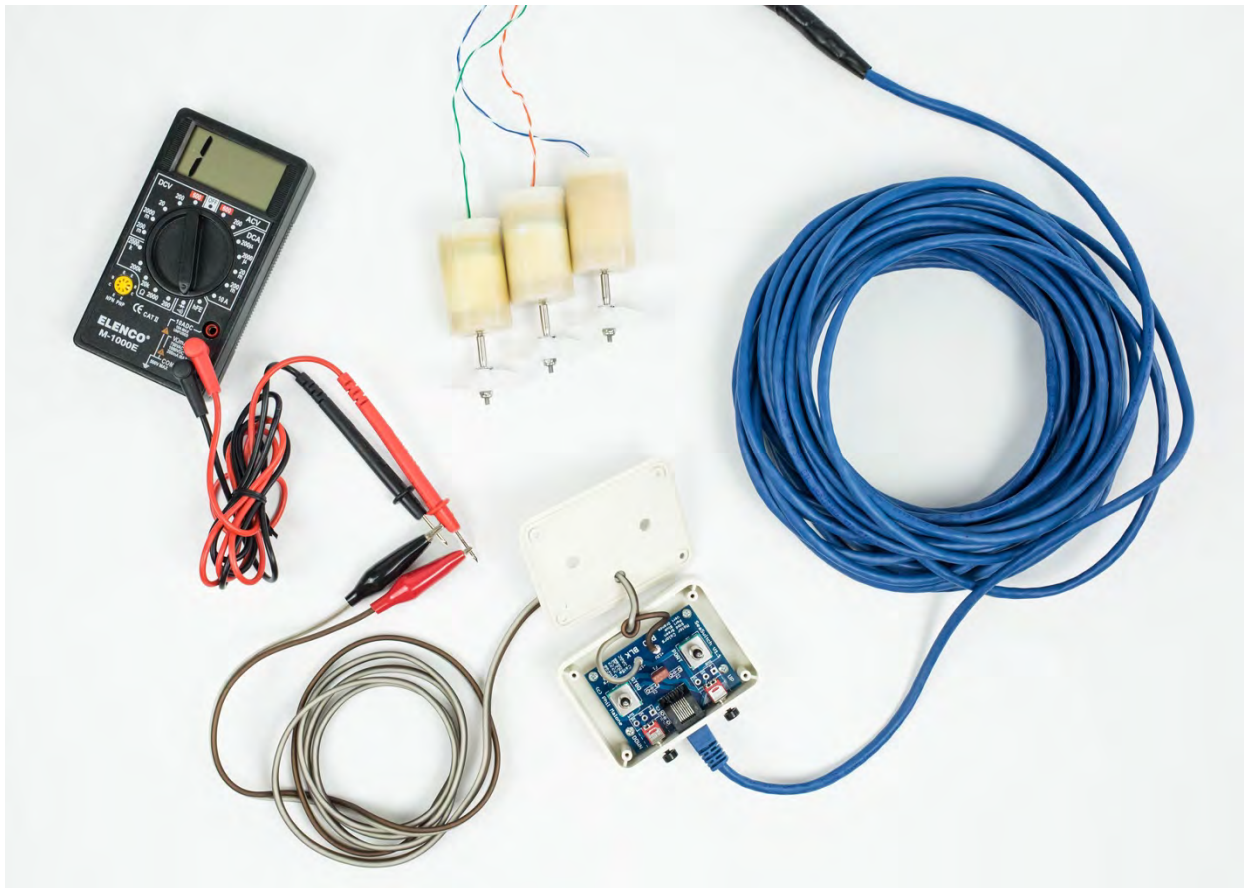

Figure 36



## Task 1.10 – Finishing the Controller

Continue only after the tests have been successfully completed.

- ❑ Place the PCB into the control box enclosure, passing the pushbutton switch actuator buttons carefully through the two holes in the top of the box.
- ❑ Use the four small silver screws to secure the PCB into the box. (Figure 37)
- ❑ Install the lid onto the control box enclosure, carefully folding the power cord wires inside the box as the lid is lowered into place. Secure the lid with the four black screws. (Figure 38)
- ❑ Press the two pushbutton switch caps onto the pushbutton switch actuators.

Final assembly shown in Figure 39.



Figure 37



Figure 38



Figure 39

**Congratulations!**  
**Controller Assembly Complete**



# SeaPerch Build Manual

## Section 2 Thruster Assembly



### SECTION OBJECTIVE

In this section, you will prepare the thruster housings, connect the tether cable wires to the thrusters, seal the motors, build the propeller assemblies, attach the propellers, and water block the tether cable.

**Completion Estimate:** 6 – 7 hours



Figure 1

## Tools Needed



Figure 2

- |                                    |                                     |                                             |
|------------------------------------|-------------------------------------|---------------------------------------------|
| 1. Table Vise                      | 7. Diagonal Cutting Pliers          | 13. Scissors                                |
| 2. Soldering Stand and Damp Sponge | 8. Wire Stripper (18 – 26 AWG Size) | 14. Permanent Marker                        |
| 3. Solder                          | 9. Needle Nose Pliers               | 15. Ruler                                   |
| 4. De-Soldering Pump               | 10. Super Glue                      | 16. Safety Glasses (1 per student & mentor) |
| 5. Soldering Iron                  | 11. 3/32" Drill Bit                 | 17. Sandpaper                               |
| 6. Alcohol Wipe                    | 12. 1/4" Nut Driver                 |                                             |

### Optional:

- Paper Towels/Clean Rags and Isopropyl Alcohol **OR** Baby Wipes
- Disposable Gloves
- Disposable Workstation Cover (paper, cardboard, etc.) for the waxing process

## Parts and Other Materials



Figure 3

1. Wax Bowl Ring
2. 50' Network Cable (tether cable)
3. Electrical Tape
4. Poly Butyl Tape
5. 3x Die Cut Vinyl Tape Set
6. 3x 4-40 Self-locking Hex Nuts
7. 3x 4-40 Tee Nuts
8. 3x 4-40 Threaded Propeller Shaft Couplers
9. 3x Propellers
10. 3x 12-Volt DC Motors
11. 3x Thruster Housings and Caps (35 mm Film Canisters with Caps)

## TASK 2.1 – Drilling Holes in the Thruster Housings



SAFETY

Put on your safety glasses.

The plastic of the thruster housings/canisters is soft enough that the holes can be “drilled” by hand by holding the 3/32” drill bit and gently spinning it through the plastic. A drill may also be used for this step (with canisters gently secured in the vise).

- Leave the caps on the thruster housings.
- Firmly grip the thruster housing in one hand and the smooth end of the drill bit in the other. **Center** the drill bit vertically over the dimple in the cap. (Figure 4)
- Twist the drill bit clockwise while applying enough pressure to make a round hole all the way through the cap.
- Pull the drill bit straight out, without twisting, to avoid enlarging the hole.
- Turn the thruster housing over and repeat to drill a hole through the **center** of the dimple in the bottom of the thruster housing. (Figure 5)



Figure 4



Figure 5

### TIP



**Center** the hole in the dimple on the bottom of the thruster housing and hold the drill bit straight (vertically), not at an angle.

If the holes are not centered or are drilled at an angle, the propeller shafts will not line up properly which may cause the housings to leak or crack when the motors are installed.

- Remove the caps and check for any plastic burrs that may be covering the hole in the bottoms of the thruster housings. It is essential to remove these burrs, as they can make it difficult to get the motor shaft to pass through the hole during the waterproofing process. (Figure 6)

To clean the burrs, use the 3/32" drill bit as a file and pass it back and forth slowly *by hand* (not using the power drill) straight through the hole from both directions, *making sure not to enlarge the hole*.

- To ensure that the hole is appropriately sized, place a motor in the canister with the propeller shaft protruding. The shaft should easily go through hole. If the hole is too small, the motor's performance will be decreased.
- Place the cap back on the thruster housing.
- Repeat until holes are drilled in the caps and bottoms of all three thruster housings. (Figure 7)

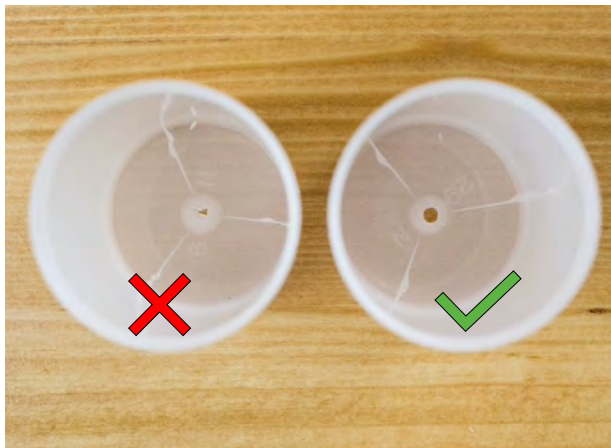

Figure 6



Figure 7

## TASK 2.2 – Preparing the Tether Cable

Refer to the **Tool Usage, Skills, and Safety Section** for more information about safely using the diagonal cutting pliers.



### TIP

Only unwind approximately 2 feet of the tether cable to complete this step.

- Using the ruler, measure approximately 15" from the bare end of the tether cable (the end without the connector).
- Make a mark using the permanent marker on the cable.
- Slightly flatten the end of the cable between your fingers.
- Place the cable on a worksurface and hold the cable far enough from the end to prevent injury if the diagonal cutting pliers slip. Use the diagonal cutting pliers to carefully slit open the outer jacket of the cable and expose about 1" of colored wires. (Figure 8)



Figure 8

- ❑ Firmly grasp the bundle of colored wires in one hand and pull on the outer jacket with the other hand, tearing the outer jacket back to the 15" mark. (Figure 9)
- ❑ Use scissors or diagonal cutting pliers to trim away the outer covering ONLY, being very careful not to nick or cut any of the colored wires. (Figure 10)

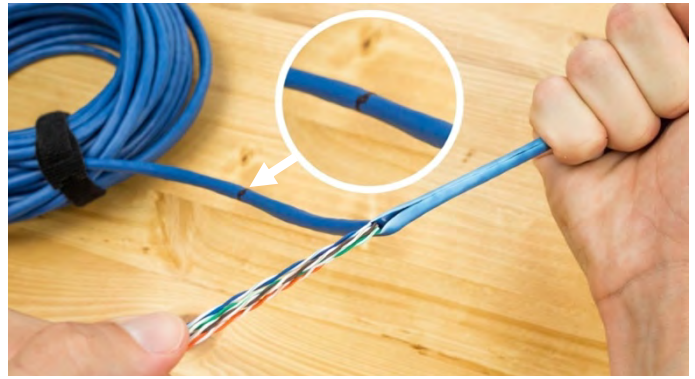

Figure 9

**TIP**

Remove only the outer covering, NOT the wires!

Four sets of colored wires should now be visible.

- **Orange** (solid and white striped)
- **Green** (solid and white striped)
- **Blue** (solid and white striped)
- **Brown** (solid and white striped)



Figure 10

The brown wires will not be used at this time. They can be cut and removed using the diagonal cutting pliers or they can be folded back and wrapped around the tether cable for later use if lights, sensors, extra motors, or other attachments are added to the ROV. (Figure 11)

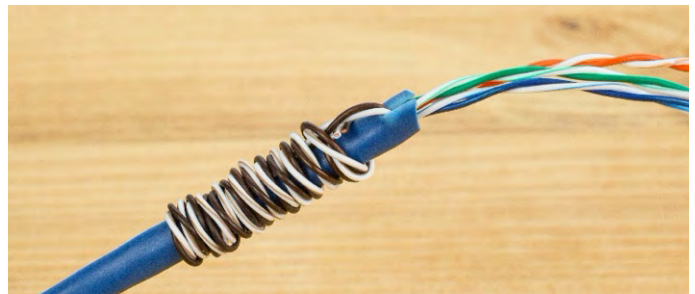

Figure 11

- ❑ With the caps on the thruster housings, run approximately 6" of one colored wire pair through the hole in one cap, going from the outside to the inside.
- ❑ Repeat for the other two wire pairs.

**TIP**

Leaving the caps on will ensure the wires are inserted in the right direction for attachment to the motors later in this section.

- ❑ Remove the caps from the thruster housings and tie a simple knot (for strain relief) approximately 1.5" from the end of each set of wires on the inside of the caps. (Figure 12)
- ❑ Repeat for the other two wire pairs.

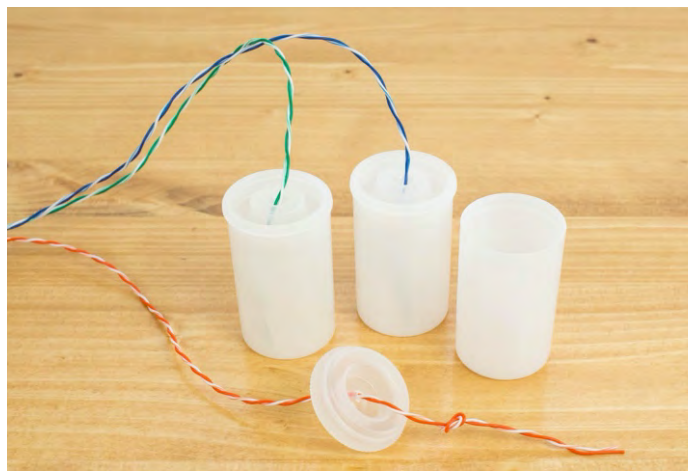

Figure 12

## TASK 2.3 – Stripping the Wires

Refer to the **Tool Usage, Skills, and Safety Section** for more information about safely using the wire stripper.

### TIP



Practice on the set of brown wires for the following steps, if unfamiliar with this skill.

Be careful not to cut or nick the individual wires. Doing so will result in a decrease in voltage to the motors.

- ❑ Untwist a set of the colored wires.
- ❑ Insert about ½" of the solid or white striped wire into the 24-gauge notch on the wire stripper.
- ❑ Cut and remove the insulation. If the insulation is not cut when using the 24-gauge notch, use the 26-gauge notch. Some wire stripper tools have slightly different hole sizes.
- ❑ Twist the exposed wire strands together immediately after stripping off the insulation to avoid fraying or breakage when attaching to the thruster terminals later in this section.
- ❑ Repeat for all colors of the solid and white striped wires. (Figure 13)

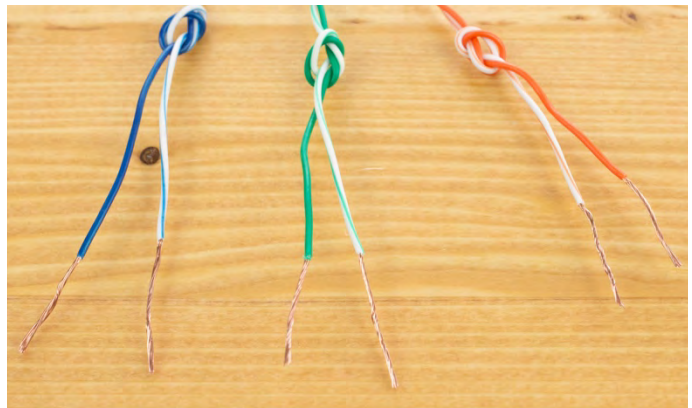

Figure 13

## TASK 2.4 – Taping the Motors (Wax-Proofing)

For wax-proofing, every hole in each motor must be sealed with the die cut vinyl tape sets to keep wax out of the motor shells during the waterproofing process. The care with which this is done will impact whether the thrusters will work and how long they will last.

Each die cut vinyl tape set consists of three pieces of tape: two circular pieces and one rectangular piece.

- ❑ The terminals on the motors may have been bent during shipping. Inspect the motors and use the needle nose pliers to *gently* straighten out and any bent terminals, *being careful not to break off the terminals*.
- ❑ Before taping, make a mark directly on the terminal that has a red dot by it using the permanent marker. (Figure 14) This is the positive side of the motor. The die cut sticker may cover the mark, so it is important to be able to correctly identify this terminal when attaching the wires to the motors later in this section.

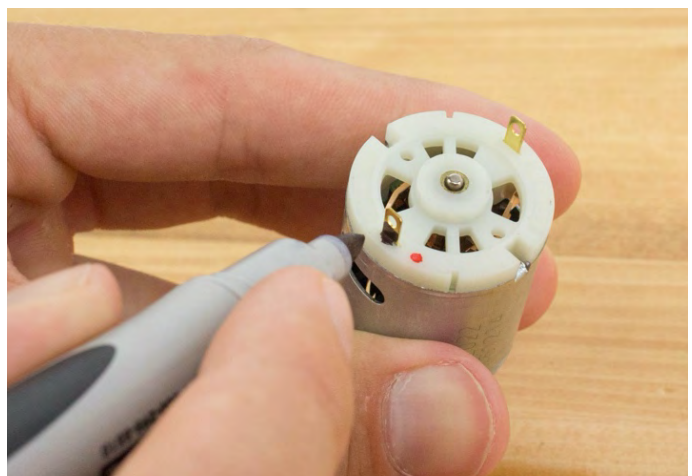

Figure 14

- ❑ To ensure proper adhesion of the die cut vinyl tape, use a clean rag/paper towel dampened with isopropyl alcohol OR a baby wipe to clean the sides of the motor. Let dry and try not to re-touch this area.
- ❑ Wrap the rectangular piece of tape around the side of the motor, beginning at a space on the motor where there are no holes. (Figure 15) Center the tape closer to the bottom or shaft end of the motor. For a tight seal, make sure the two ends **do not** meet over any of the holes as this may allow wax inside the motor shell.
- ❑ Wipe the terminal end of the motor with the alcohol-dampened rag or baby wipe. Let dry and try not to re-touch this area.
- ❑ Place one of the circular pieces of tape on the motor with the flat edges of the circular tape resting against the terminals. (Figure 16)
- ❑ Wipe the shaft end of the motor with the alcohol-dampened rag or baby wipe. Let dry and try not to re-touch this area.
- ❑ Place the last piece of circular tape on the shaft end of the motor, lining the flat sides of the tape up with the two small threaded holes. (Figure 17)
- ❑ Smooth out any bubbles or ripples until the tape on the sides, top, and bottom of the motor lies flat, creating a good seal.
- ❑ Repeat this taping process for the other two motors. (Figure 18)



Figure 15



Figure 16



Figure 17



Figure 18



## TASK 2.5 - Connecting the Tether Cable Wires to the Motors

Refer to the **Tool Usage, Skills, and Safety** section for more information about using the soldering iron and the table vise.

### SAFETY



Put back on your safety glasses.

- ❑ Install the table vise to the workstation and place both rubber pads on the jaws of the vise.
- ❑ Clamp one of the taped motors into the table vise with the terminals pointing upward. It should be tight enough so that the motor will not move but not so tight that the motor could be crushed.
- ❑ Select a pair of colored wires (orange, blue, or green).
- ❑ Insert the twisted end of the **solid color wire** through the hole in the **positive (red) terminal** (*marked earlier in Task 2.4*). Twist and squeeze the wires around the terminal using the needle nose pliers to make a solid mechanical connection.
- ❑ Insert the twisted end of the **white striped wire** through the hole in the other (**unmarked**) terminal.
- ❑ Twist and squeeze the wires around the terminal using the needle nose pliers to make a solid mechanical connection. (Figure 19)

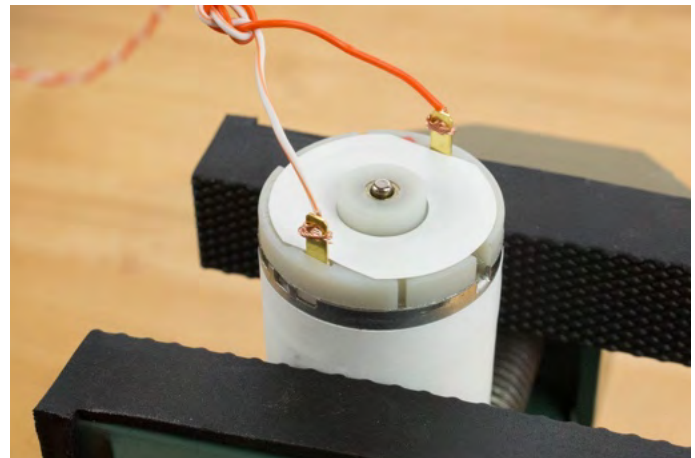

Figure 19



### TIP

It is important to have solid connections before soldering to ensure proper heat transfer while soldering and to create a strong solder joint.

- ❑ Heat the soldering iron. Clean and tin the tip.



### TIP

The key to good soldering is to keep the tip of the iron clean. As the iron heats up over time, the tip will oxidize or turn dark, and the solder will not stick.

- ❑ Hold the tip of the soldering iron parallel to one of the terminals, touching the terminal and the wire for a few seconds to heat the connection. (Figure 20)
- ❑ From the opposite side of the terminal, feed solder on until it flows over the connection. This will take approximately five seconds.

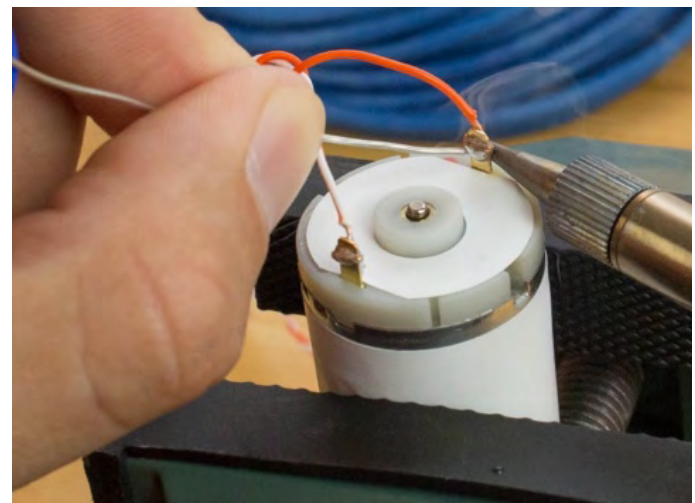

Figure 20

Be careful not to burn the colored insulation on the wires, the vinyl tape that is covering the motors, or the plastic ring on the top of the motor.

- Remove the solder and then remove the soldering iron tip from the solder joint. Avoid touching or disturbing the connection for a few seconds until it cools and hardens to ensure a good electrical connection. (Figure 21)



**TIP**

Soldering Order:  
Iron on → solder on → solder off → iron off

- Repeat until solid and white striped wires for all three motors have been soldered, remembering to keep the soldering iron's tip hot, cleaned, and tinned each time.
- Once all the connections are cool, use the end of the needle nose pliers to gently bend the terminals down and inward, flat against the top of the motor. (Figure 22)



**TIP**

Motors can be tested at this point if a controller that is known to be working correctly is available.

- Test the thrusters by attaching the tether cable's RJ-45 connector to the controller.
- Attach the alligator clips to the battery, black clip to black terminal, red clip to red terminal.
- Hold the motors or tape them to a worksurface. When powered the motors can move quickly and may tangle the wires if not held in place.
- Press each of the four switches (2 pushbuttons, 2 toggles), one at a time, and observe the operation of each thruster motor.

The motor shafts should spin rapidly in a counterclockwise direction (looking into the end of the shaft) whenever the toggle switches are switched to "forward" (horizontal thrusters) and when the pushbutton switches are switched to "down" (vertical thruster).

- Check the opposite directions.



**TIP**

Wrapping a small piece of electrical tape around the end of the motor shaft will make it easier to determine which direction it is turning.

- If a motor shaft does not spin or spins slowly, with all switches in the off position, gently twist it in both directions by hand. Test again to make sure that they spin properly.

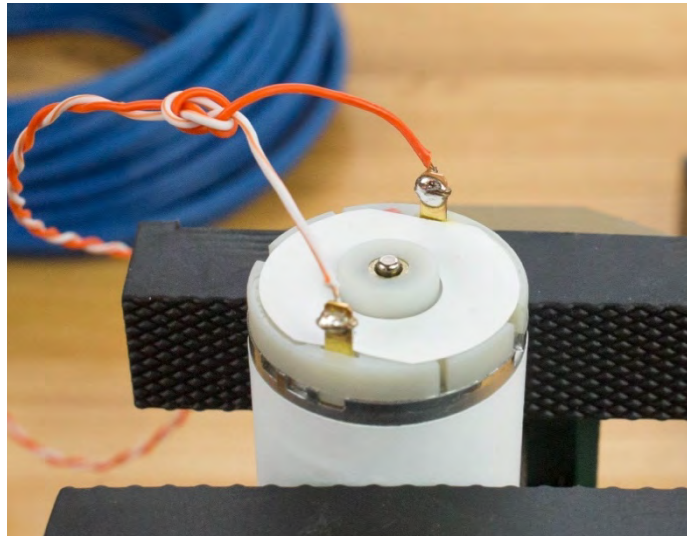

Figure 21

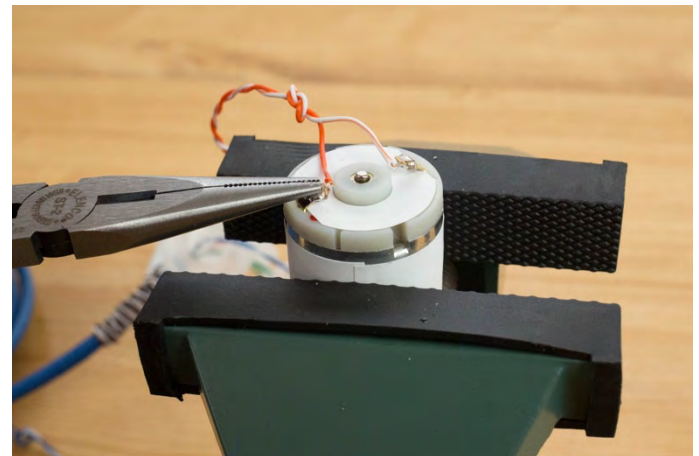

Figure 22

## TASK 2.6 – Assembling and Installing the Propellers

Refer to the **Tool Usage, Skills, and Safety Section** for more information about safely using the table vise and needle nose pliers.

- Attach the table vise to your workstation.
- Remove both rubber pads from the jaws of the table vise and set them aside.
- Look closely at a propeller and locate the slot/groove on one end of the hub. Using a permanent marker, mark this slot/groove on each of the three propellers. (Figure 23)



Figure 23



### SAFETY

Handle the tee nuts and propellers with care - the prongs and blades are very sharp.

Build the propeller assemblies as follows (Figure 24):

- Mount approximately ½" of the hollow end of propeller shaft in the V-groove of the vise jaws. Tighten the table vise, being careful not to crush the end of the propeller shaft.
- With the **prongs facing upward**, thread the tee nut all the way down the threaded coupler. (Figure 25) Needle nose pliers may be used to get the tee nut started on the threaded coupler and to tighten it all the way down. Make sure not to bend/fold the prongs over as these hold the propellers in place.
- Thread a propeller onto the threaded coupler with the **slot/groove side that was marked earlier facing downward**, toward the tee nut.
- Thread a self-locking hex nut onto the threaded coupler with the white plastic nylon insert facing upward/flat part of the hex nut facing downward.
- Using the ¼" nut driver, drive the assembly together by tightening the self-locking hex nut. Eventually, the propeller will begin to spin during the tightening process.
- In one hand, grip the propeller by one of its blades using a rubber vise jaw pad and continue to tighten the hex nut with the nut driver in the other hand. (Figure 26)
- Tighten until the plastic hub of the propeller is flush against the tee nut. There should not be a gap between the propeller hub and the tee nut.

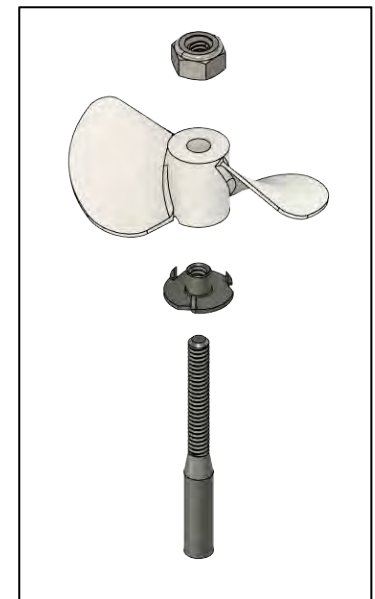

Figure 24



Figure 25

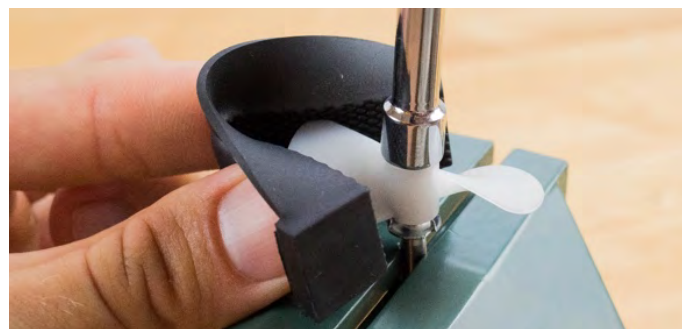

Figure 26

**TIP**

If you are having difficulty getting the propeller hub flush against the tee nut, it is possible that the shaft is spinning in the table vise as you are tightening with the nut driver. To tell if this is the case, make a stripe on the propeller shaft with the permanent marker and watch if the stripe spins/moves as you tighten with the nut driver. If it does, tighten the table vise a little, still being careful not to crush the propeller shaft.



Figure 27

Repeat for the other two propellers. Completed propeller assemblies are shown in Figure 27.

**Do not** attach the propeller assemblies to the motors yet!

## TASK 2.7 – Waxing the Motors (Waterproofing)

**TIP**

The waxing process can be messy. Use a piece of cardboard, butcher paper, plastic tablecloth, or similar disposable material to cover the workstation for easier clean-up. The wax may stain clothing, so participants should dress accordingly for this task. Disposable gloves used during the waxing task work best when they are tight fitting. Gloves are optional, but their use does expedite the clean-up process.



**SAFETY**



Put on the disposable gloves (optional) and safety glasses.

Do not ingest the wax. Hands should be washed with warm water and soap after handling the wax.

Clear the work area of everything other than the materials needed for this task:

- Three motors with wires attached
- Three thruster housings with caps
- Bowl wax ring
- 3/32" drill bit
- Disposable gloves (optional)
- Safety glasses

□ Before waxing, place the motor in the thruster housing to ensure that the shaft protrudes through the hole in the bottom. If it does not, hold the 3/32" drill bit and gently spin it by hand to open the hole a little further to help with alignment.

- ❑ Pinch a ¾" to 1" long piece of wax from the wax ring. Roll the piece of wax between the palms of your hands until it is softened and forms a ball. The wax ball should be slightly smaller than the diameter of the thruster housing.
- ❑ Drop the ball of wax into the thruster housing. (Figure 28)

**TIP**



Alternatively, coat the bottom of the canister with ~1/8" of wax. Then lightly coat the sides of the canister to ensure that enough of the motor shaft protrudes through the hole.

- ❑ Being careful not to grasp the soldered wires, gently press the motor, shaft first, into the thruster housing and align the shaft with the drilled hole in the bottom. (Figure 29)
- ❑ Continue pressing the motor until the shaft protrudes through the drilled hole.
- ❑ Once the shaft protrudes through the bottom of the thruster housing, place the first two fingers of both hands on the thruster end of the thruster housing and position both thumbs on the wired end.
- ❑ Press together firmly until the motor shaft protrudes 1/4 - 5/16" from the thruster housing. (Figure 30) This will disperse the wax across the bottom of the housing and force some of the wax up the side of the motor. (Figure 31)

A tight-fitting seal around the hole in the bottom of the thruster housing is most important for long thruster life.



Figure 28



Figure 29



Figure 30

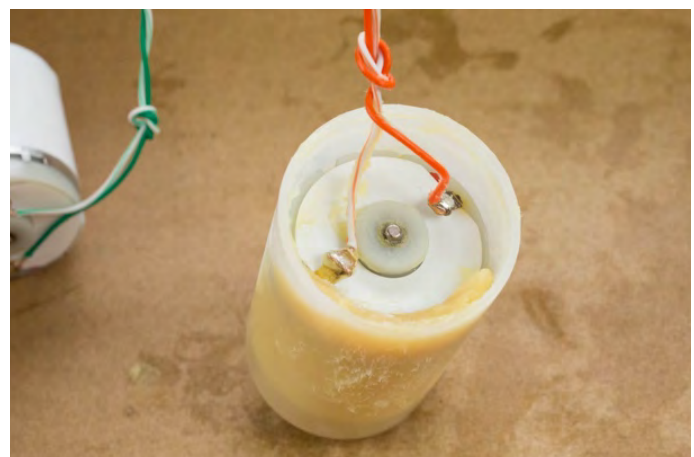

Figure 31

- ❑ Coil the wires into the end of the thruster housing.
- ❑ Roll a marble-sized piece the piece of wax between the palms of your hands until it softens and forms a ball.

- ❑ Press the wax into the thruster housing to cover the wires and fill the remaining area at the top and sides of the housing/canister. Leave just enough space for the cap to go on. (Figure 32)
- ❑ Place the lid onto the housing and press hard to seat it into place. Be careful not to pinch/crimp the wires between the cap and the thruster housing. If the lid does not close tightly, it may be necessary to remove some of the wax.
- ❑ Use a paper towel or rag to wipe the wax from the outside of the thruster housing and the motor shaft. Paper towels/rags dampened with isopropyl alcohol or baby wipes can be used to remove any remaining waxy residue.
- ❑ Repeat for the other two thrusters. (Figure 33)
- ❑ Thoroughly wash your hands with soap and warm water.



Figure 32

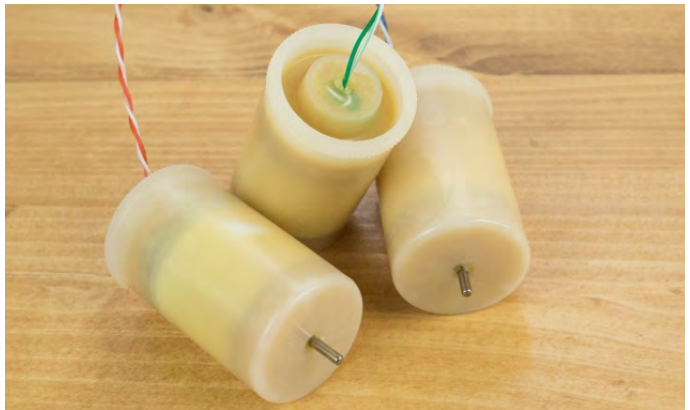

Figure 33

## TASK 2.8 -Attaching the Propeller Assemblies to the Motors

Start with clean, wax-free hands.

- ❑ Wipe a motor shaft with an alcohol wipe to completely remove excess wax or residue that may be left after the waterproofing process. (Figure 34)
- ❑ Use a small piece of sandpaper to roughen the surface of the motor shaft so the adhesive will stick better. Be sure to roughen all sides as well as the end of the motor shaft. (Figure 35)
- ❑ Thoroughly wipe the thruster shaft again with the alcohol pad to remove the sandpaper grit and residue. *Do not touch the motor shaft*; oil from your hands will prevent proper adhesion of the glue. Cleaning, roughing, and re-cleaning the motor shaft is critical for the adhesive to stick.



Figure 34



Figure 35

**SAFETY**



Adhesives can present hazards to skin and eyes. Wearing eye protection and gloves is recommended when working with any adhesives. Hands should always be washed after working with such materials.

- Place one small drop of Super Glue on the motor shaft near the end (Figure 36) and one small drop in the hollow end of the shaft coupler. (Figure 37)



Figure 36



Figure 37

- Push the hollow end of the shaft coupler onto the motor shaft. Leave a slight gap (about 1/16") between the shaft coupler and the thruster housing.
- Using a paper towel, wipe away any excess glue between the shaft coupler and the motor shaft. (Figure 38)
- Set the thruster aside undisturbed for at least 15 minutes until the adhesive hardens.
- Once the glue is set, turn the motors by hand to free up the newly installed assembly.
- Repeat for the other two thrusters. Three completed thruster assemblies are shown in Figure 39.

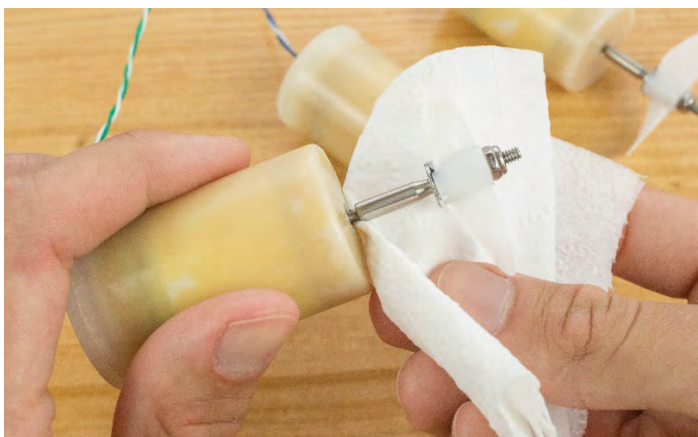

Figure 38

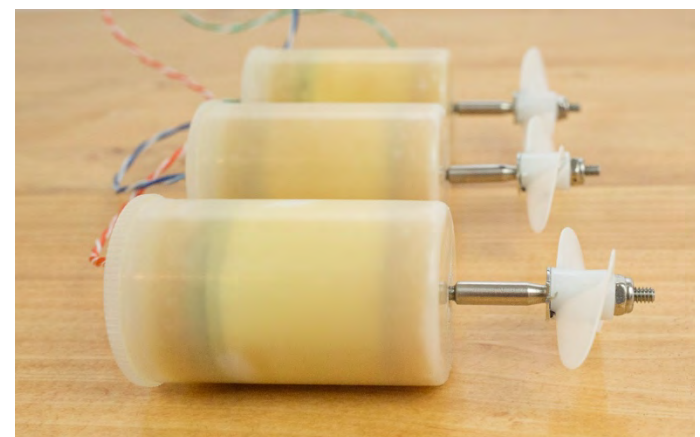

Figure 39

## TASK 2.9 – Water Blocking the Tether Cable



**TIP**

If the tether cable is not properly water blocked, water will wick up the entire length of cable, through the RJ-45 connector, and into the controller, causing ROV failure.

- ❑ Cut the poly butyl rubber tape into three equally sized strips and peel off the backing. (Figure 40)



**TIP**

Poly butyl rubber tape is self-vulcanizing, meaning that it sticks to itself and anything else it touches (to include clothing). Keep the workspace covered and dress appropriately.

- ❑ Stretch a strip of the poly butyl rubber tape to 2-3 times its relaxed length, starting at one end and working toward the other. Avoid pulling on either end at the same time as this will cause the tape to break in the middle.
- ❑ Interweave (wind) a strip of the poly butyl rubber tape around the wire pairs where they emerge from the outer jacket of the tether cable. Knead and work it in so that it seals both around and between the wires and forms a smooth seal over the jacket opening to prevent water from getting inside the tether cable. (Figure 41)
- ❑ Stretch another piece of the poly butyl rubber tape to 2-3 times its relaxed length as described above. Wrap it around the interwoven piece.
- ❑ Wrap the last piece of poly butyl rubber tape around the area of cable with the brown wire pair. (Figure 42)

A water blocked tether cable should resemble Figure 43.

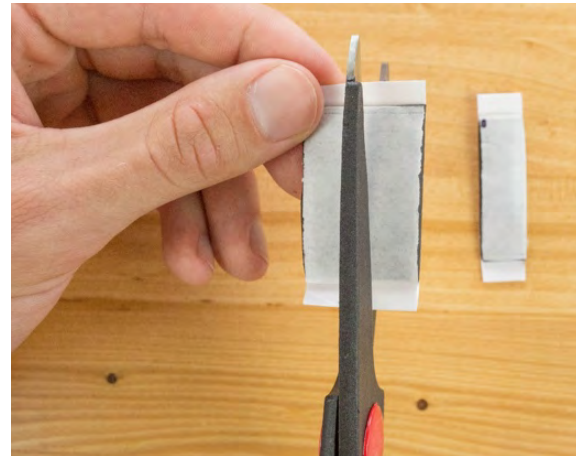

Figure 40

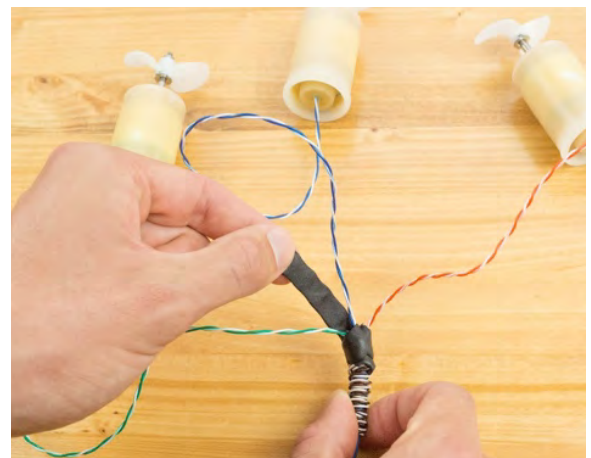

Figure 41

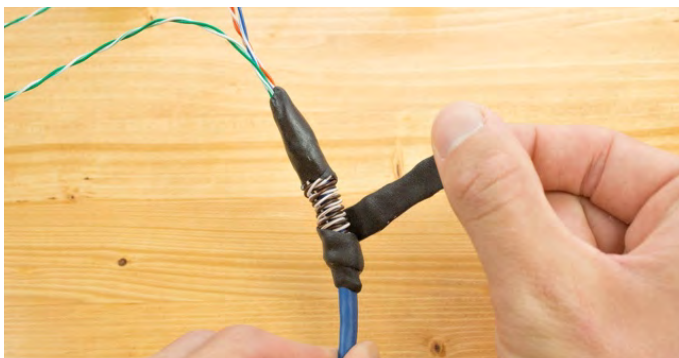

Figure 42

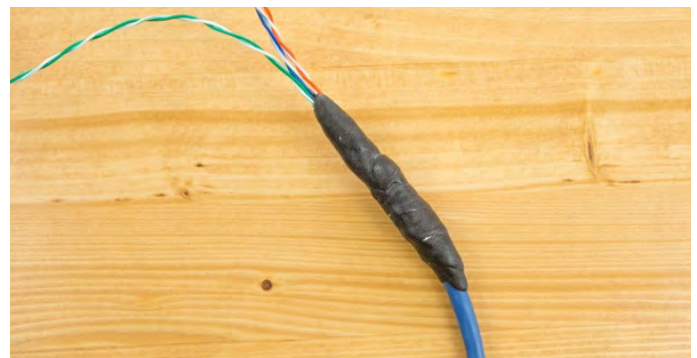

Figure 43



- Wrap electrical tape over the poly butyl rubber tape from end to end to completely cover the poly butyl tape. This will keep the poly butyl tape from sticking to anything. (Figure 44)

If you choose to use the brown wire pair in the future, the electrical tape and poly butyl rubber tape will need to be carefully peeled off at that time.



Figure 44



**TIP**

Thrusters can be re-tested at this point if a "known-to-be-good" controller is available, following the steps in Task 2.5.

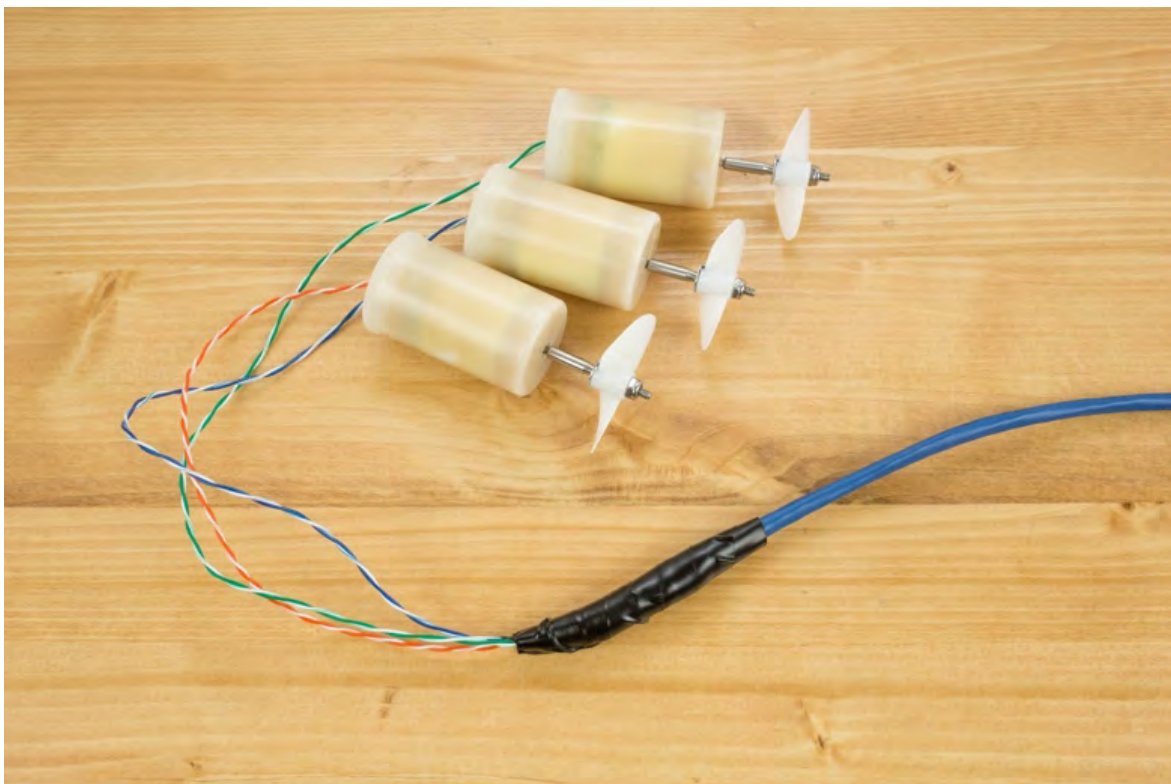

Figure 45

# Congratulations!

## Thruster Assembly Complete



# SeaPerch Build Manual

## Section 3 Frame Assembly



### SECTION OBJECTIVE

In this section you will measure, mark, cut, and drill holes in the PVC pipes elbows, assemble the frame, attach buoyancy floats, and attach the payload net (optional).

**Completion Estimate:** 4 – 5 hours



Figure 1

## Tools Needed

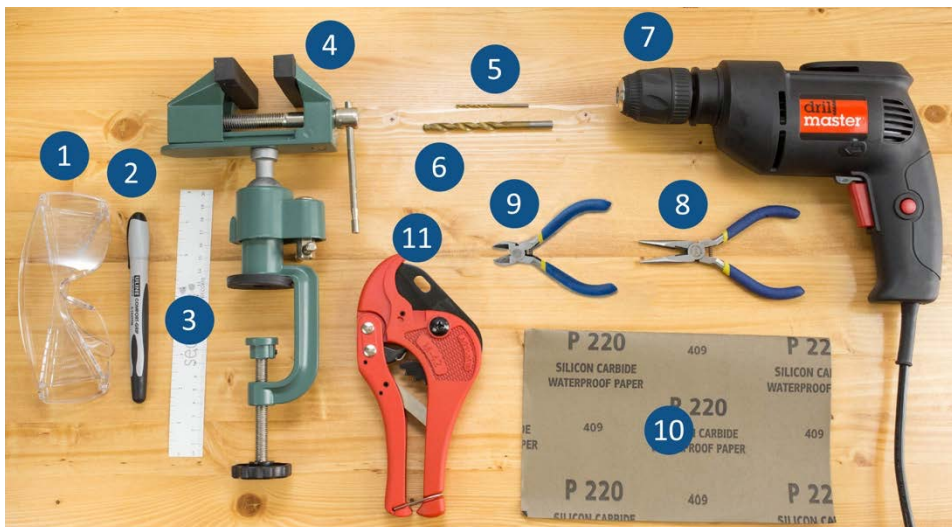

Figure 2

1. Safety Glasses (1 per student & mentor)
2. Permanent Marker
3. Ruler
4. Table Vise (mounted to a sturdy workstation)
5. 3/32" Drill Bit
6. 1/4" Drill Bit
7. Electric Hand Drill
8. Needle Nose Pliers
9. Diagonal Cutting Pliers
10. Sandpaper
11. PVC Pipe Cutter

## Parts and Other Materials



Figure 3

1. 5" Buoyancy Floats (2 each)
2. 1/2" Schedule 40 PVC pipe (Six 12" sections)
3. 1/2" PVC 90° Elbows (10 each)
4. 1/2" PVC Tees (4 each)
5. 12" x 8" Black Polyethylene Mesh
6. 6" Cable Ties

### Optional Materials (not pictured):

- Waterproof paint
- Rubber mallet
- Painters Tape
- Scissors

## TASK 3.1 – Choose Your SeaPerch

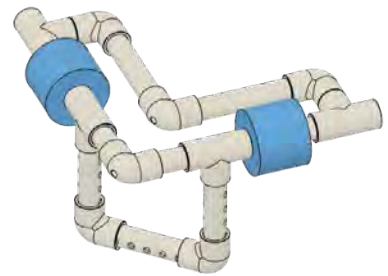
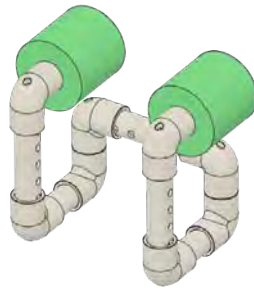
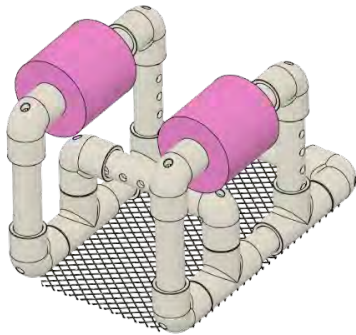

Utility ROV	Mini ROV	V-Wing ROV
<ul style="list-style-type: none"> <li>• General Purpose</li> <li>• Stable</li> <li>• Easily add sensors</li> <li>• Easily add camera</li> <li>• Easily add additional thrusters</li> </ul>	<ul style="list-style-type: none"> <li>• Inspection and Observation</li> <li>• Small</li> <li>• Light</li> <li>• Agile</li> <li>• Easily add small camera</li> </ul>	<ul style="list-style-type: none"> <li>• Sleek</li> <li>• Agile</li> <li>• Easily reconfigure for design experimentation</li> </ul>

Using the materials from one SeaPerch ROV kit, you can choose to build one of three different frame designs. Think about your ROV's mission as you decide which frame to build.

The pipe measurements are the same for the three designs; however, each design uses different quantities of the pipes and fittings.

Extra pipe can be used later for adding attachments to the ROV or for frame modifications discussed more in-depth in the Engineering Design Process Section.

ROV Frame Options – Materials List			
Pipes and Fittings	Utility ROV	Mini ROV	V-Wing ROV
1-1/2" long pipe	6	2	2
2-1/2" long pipe	2	2	2
4" long pipe	6	5	5
5" long pipe	2	n/a	2
90° Elbow	10	8	6
Tee	4	n/a	4
Buoyancy Floats	As required	As required	As required
Payload Net (approximate size)	5-1/2" x 9"	n/a	n/a

## TASK 3.2 – Cutting the PVC Pipes

### SAFETY



Do not put fingers inside the PVC pipes. They can become stuck and cause injury.



### TIP

The large blue cable ties used for mounting the motors are shipped inside one of the PVC pipe sections. Locate and remove the blue cable ties before cutting the pipes and set them aside for use later.

Refer to the **Tool Usage, Skills, and Safety Section** for information about safely using the table vise and PVC cutter.

- Mount the table vise to your workstation.
- Position one section of PVC pipe in the table vise. (Figure 4)
- For a tighter grip on the PVC pipe, remove the rubber pad from the side of the table vise that has the V-shaped groove on the jaw. You will need this rubber piece again later, so set it aside where it will not be lost, damaged or discarded.
- Using the Pipe List and Cutting Guide (Figure 6 on next page), precisely measure and mark the PVC pipes. Use the checkboxes to keep track of which pieces have been marked and cut.

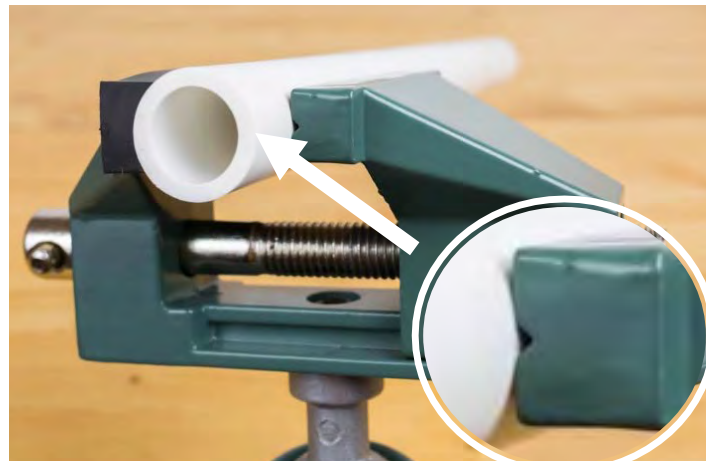

Figure 4



### TIP

Measure and cut all the pipes in the cut list below so you can reconfigure your frame for any of the three designs.

- Use a marker to write the length in the middle or towards the end of each pipe section. (Figure 5) Avoid writing the lengths directly on or above the mark lines. Measurements may be sliced through when the pipe is cut, making identification of pipe lengths difficult when assembling the frame later in this section.



Figure 5



### TIP

For maximum use of time, students can work in pairs with one student steadying the pipe and holding the ruler against the pipe while the other measures, makes the marks, and labels the lengths. Have students switch roles so each gets to practice these skills.

Pipe List and Cutting Guide

- 2 each 5" long
- 6 each 4" long
- 2 each 2-1/2" long
- 6 each 1-1/2" long

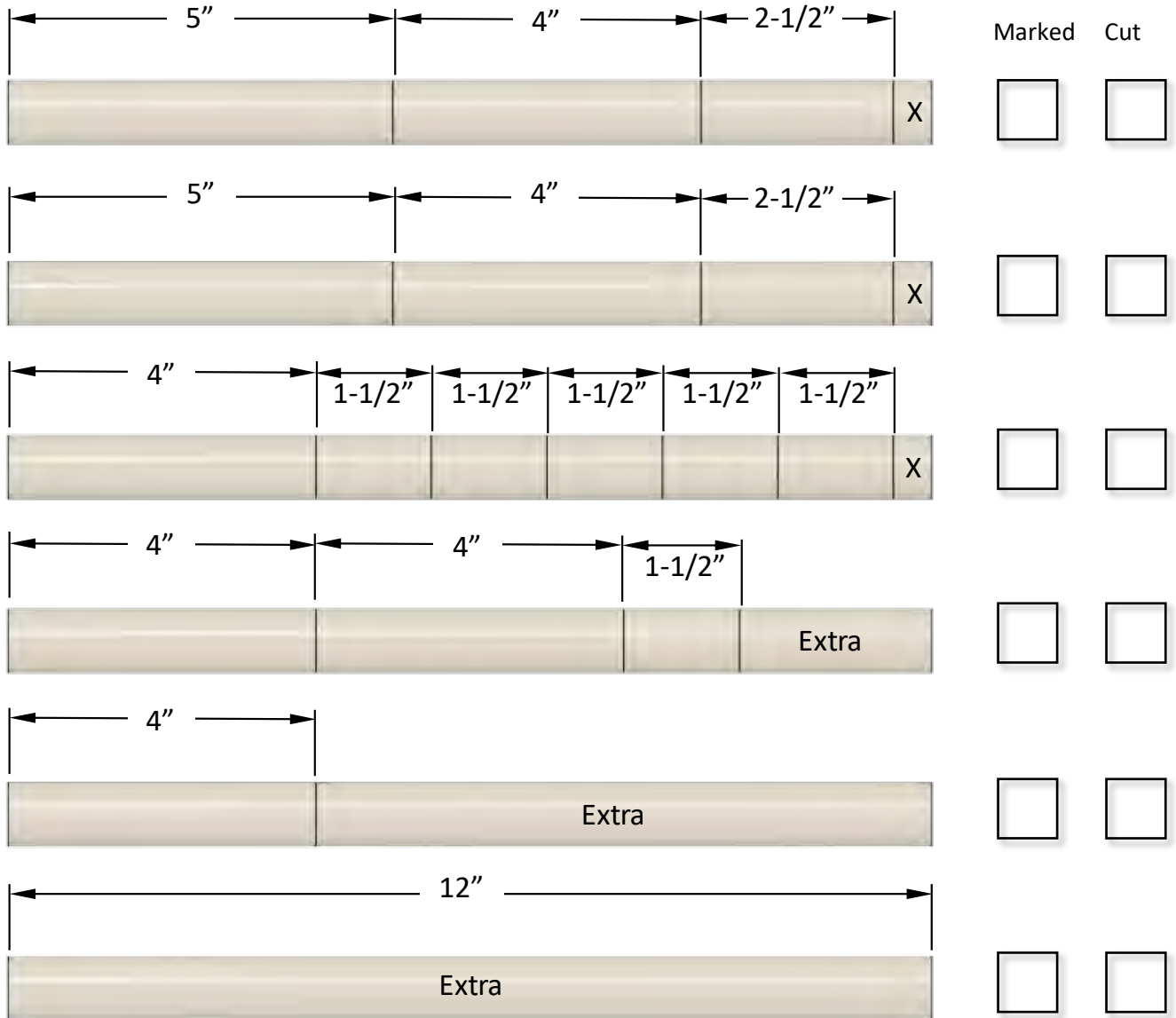

Figure 6

SAFETY



Put on your safety glasses.

Always keep hands and fingers away from the blade of the pipe cutter. **Do not** try to catch the cut piece of pipe! Let it fall and pick it up later.

- Tightly clamp one of the marked PVC pipe sections in the table vise so that *the shortest* pieces are cut first since these cannot be easily secured in the vise jaws later.
- Position the cutting blade of the pipe cutter on the top of the pipe, aligned with the cutting mark, and cut through the pipe. Try to cut straight across the pipe. (Figure 7)
- Reposition the PVC pipe in the table vise until the next cut mark is visible and easily accessible.
- Repeat until all sections have been cut. (Figure 8)

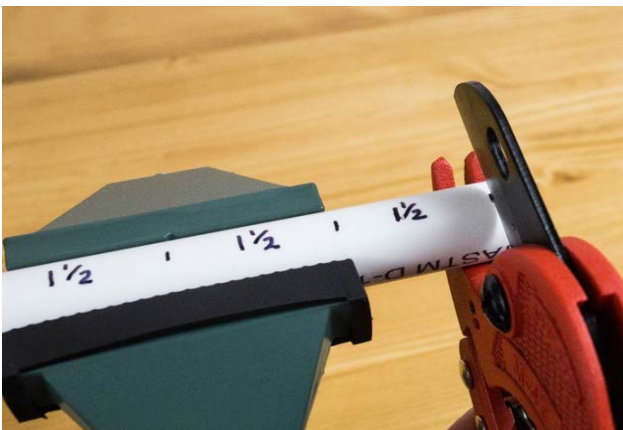

Figure 7

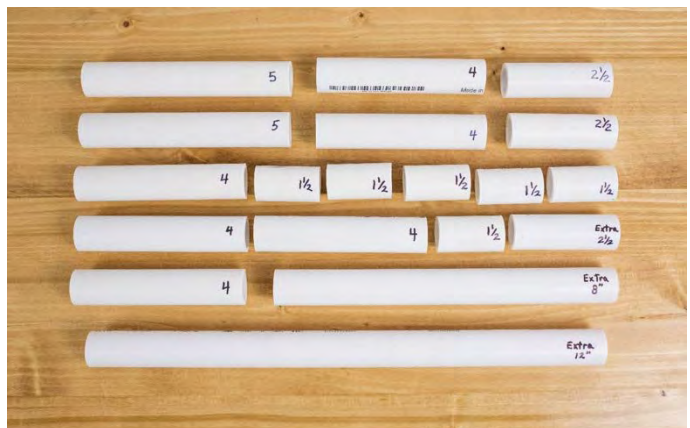

Figure 8

## TASK 3.3 – Drilling the Thruster Mounting Holes

Refer to the **Tool Usage, Skills, and Safety Section** for more information about safely using the drill and drill bits.

- Locate three 4" long pipe pieces.
- For ease of marking and accuracy, secure each piece of pipe in the table vise when measuring (shown previously in Figures 4 & 5).
- Hold the ruler parallel to the pipe. Mark the locations of the thruster mounting holes with a straight line along the edge of the ruler to intersect with the hole location marks. (Figure 9)
- Repeat for the other two 4" pipes.
- Clamp the pipe in the table vise, with the marks facing upward, and with one of the rubber pads removed from the table vise.

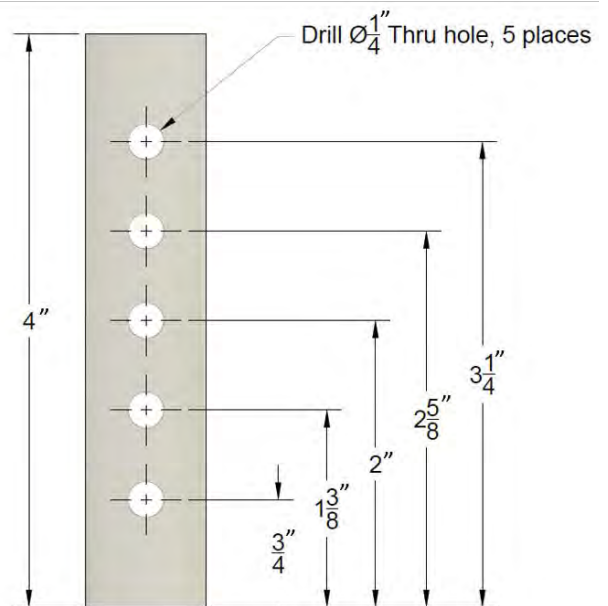

Figure 9

**SAFETY**



**Always** use the table vise when drilling the pipes. Never try to hold the pipes or fittings by hand.

Make sure to align the pipe so the drill bit will not strike the table vise when drilling through the pipe.

- ❑ Insert the 3/32" drill bit into the drill. Begin drilling a "pilot hole", a small starter hole that will help line up the larger 1/4" drill bit.
- ❑ Center the bit over a thruster mount marking and apply light pressure to pull the trigger until enough speed is reached to make the pilot hole. The bit does not have to go all the way through the pipe.
- ❑ Reposition the pipe as necessary and drill the pilot holes in each marked location. (Figure 10)
- ❑ Repeat for the other two 4" pipes.
- ❑ Remove the 3/32" drill bit and insert the 1/4" bit. Center the 1/4" bit over a pilot hole. Apply light downward pressure, and gently pull the trigger until enough speed is reached to go all the way through the pipe. (Figure 11)
- ❑ Reposition the pipe as necessary to drill the remaining 1/4" holes.
- ❑ Repeat for the other two 4" pipes.
- ❑ Remove the sharp edges from the holes using abrasive (sand) paper. (Figure 12)

Finished result shown in Figure 13.



Figure 10



Figure 11



Figure 12



Figure 13



## TASK 3.4 – Drilling the Vent/Drain Holes

Drilling vent/drain holes in the PVC elbows allows water to fill the frame when the SeaPerch is placed into the water and allows the water to drain out when removed from the water.

- Clamp one elbow in the table vise as shown with both rubber pads on the vise jaws. (Figure 14)
- Use the 1/4" diameter drill bit to drill a hole through the corner of the pipe elbow. *Drill from the interior of the elbow outward* to eliminate the need for a pilot hole and to avoid slipping of the drill bit.

### SAFETY



**Always** use the table vise when drilling the fittings. Never try to hold them by hand.

Make sure to align the PVC elbow so the drill bit will not strike the table vise when drilling through the fitting. Striking the vise with the bit may result in breaking or damaging the bit.

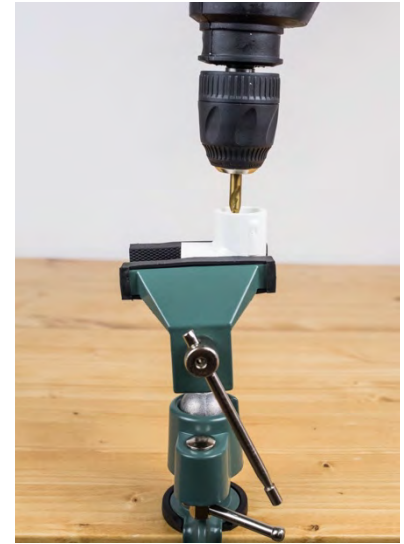

Figure 14

- Drill vent/drain holes in all ten elbows that come with the kit. Not all ten elbows are used in each design, but if you decide to change your design later, the holes will already be drilled.

Remove any sharp edges from the holes using abrasive (sand) paper. Finished result shown in Figure 15.



Figure 15

## TASK 3.5 – Assembling the ROV Frame

The standard 5” foam floats that are supplied in the SeaPerch ROV kits have a significant amount of buoyancy when in shallow water.

- To adjust this buoyancy, place one of the 5” foam floats on the workstation and cut it into two 2” sections using scissors, a utility knife, or a serrated kitchen knife.

Additional small slices of the remaining float material can be used to further adjust buoyancy during final assembly and ballasting.

Follow the assembly illustrations shown below for your chosen frame design.



### TIP

For all three frame options, it is easiest to assemble each side of the frame first and then connect the sides together with the cross pipes. No glue is used for any of the connections.

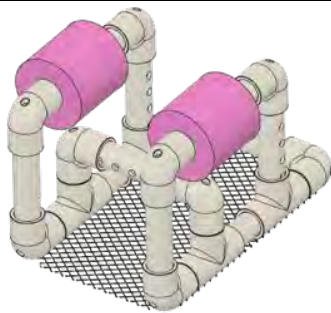

**Utility ROV**  
(Task 3.5A)



**Mini ROV**  
(Task 3.5B)



**V-Wing ROV**  
(Task 3.5C)

## TASK 3.5A – Utility ROV Frame Assembly

Construct the Utility ROV Frame as shown in Figure 16.

- ❑ Insert the 5" long pipes into the 2" long floatation pieces before connecting the elbows. (Figure 17)
- ❑ Position the thruster mounting pipes with the holes facing as shown. (Figure 17)
- ❑ Assemble the lower right section (Figure 18) and the lower left section (Figure 19). These sections are identical except for the orientation of the upper and lower cross support elbows.
- ❑ Assemble the upper and lower frame sections (right and left sides). (Figures 20 & 21)

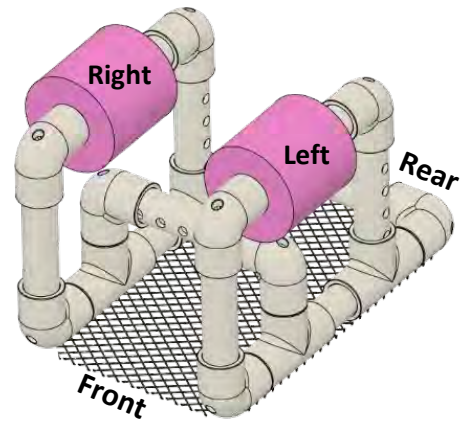

Figure 16

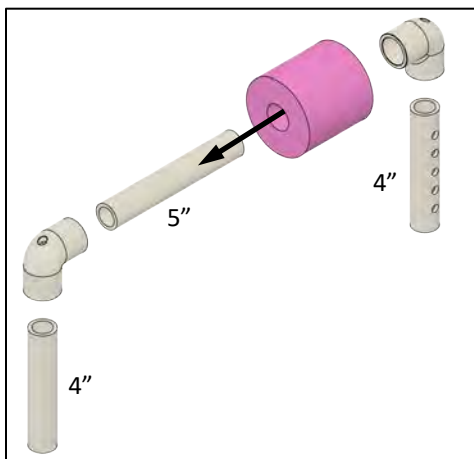

Figure 17

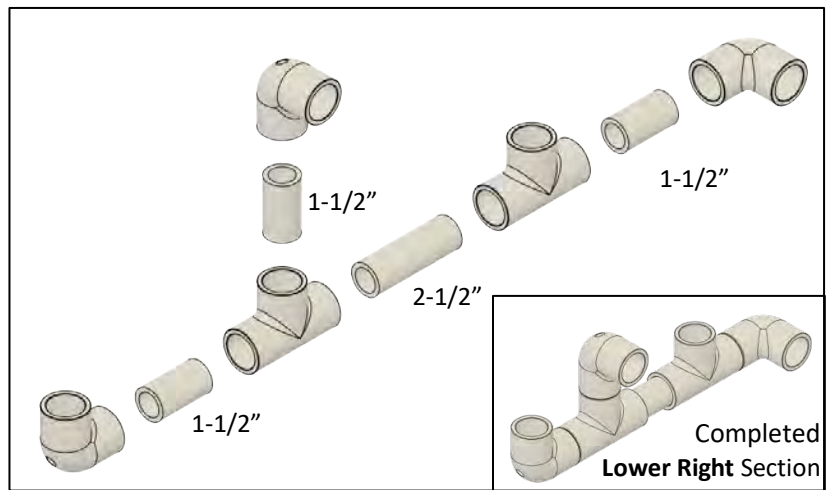

Figure 18

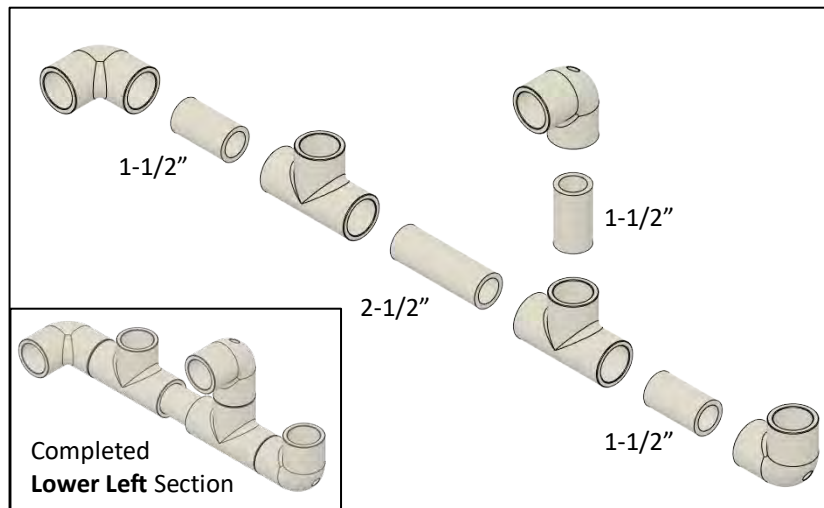

Figure 19

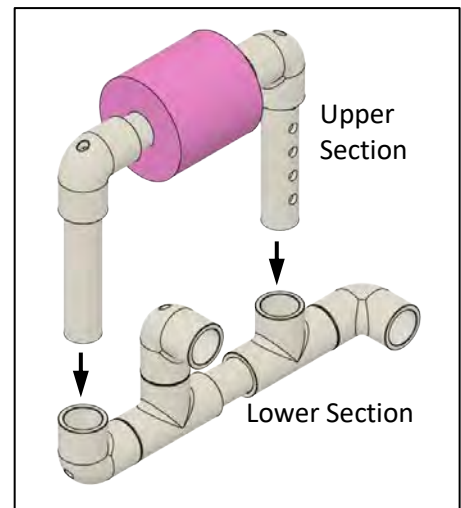

Figure 20

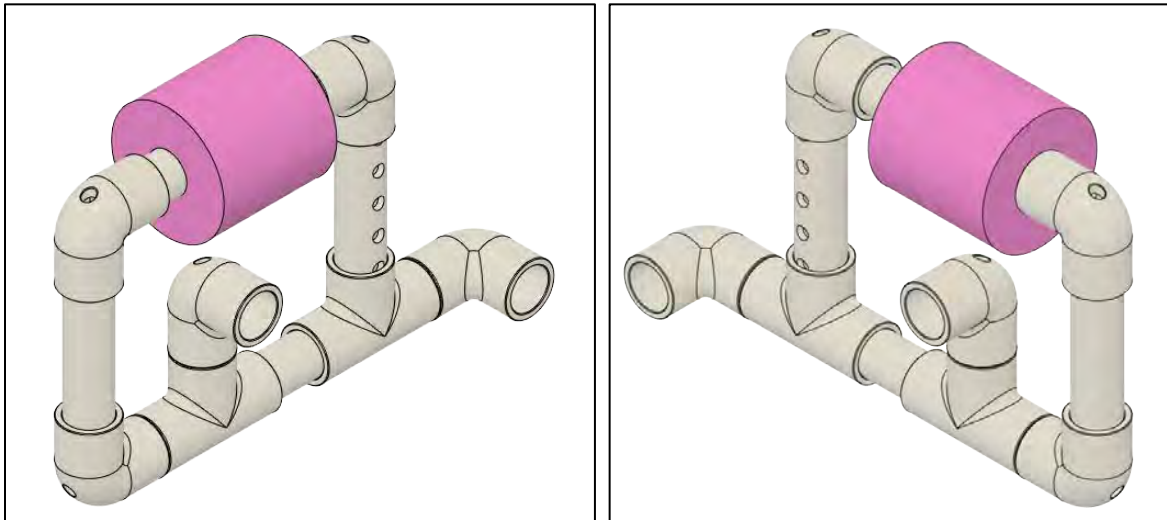

Figure 21

- Connect the two frame side sections using a 4" long pipe and 4" long thruster mounting pipe as shown in Figure 22.

Completed Utility ROV Frame is shown in Figure 23. An optional payload net can be added using the instructions in Task 3.7.

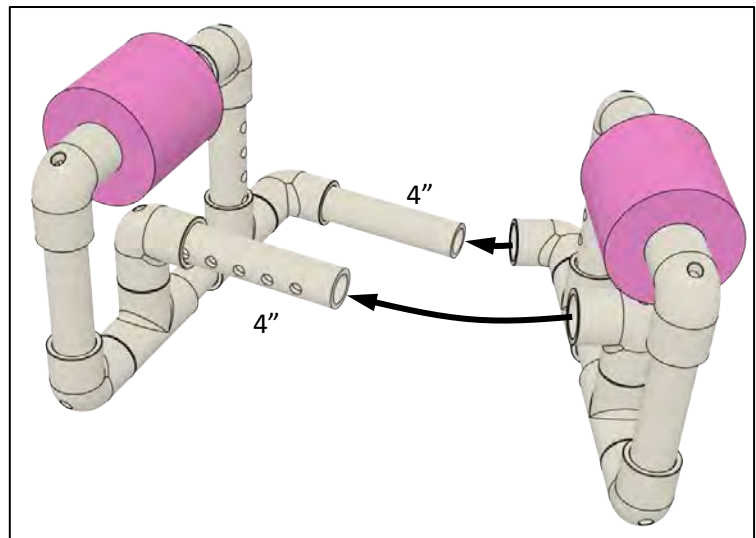

Figure 22

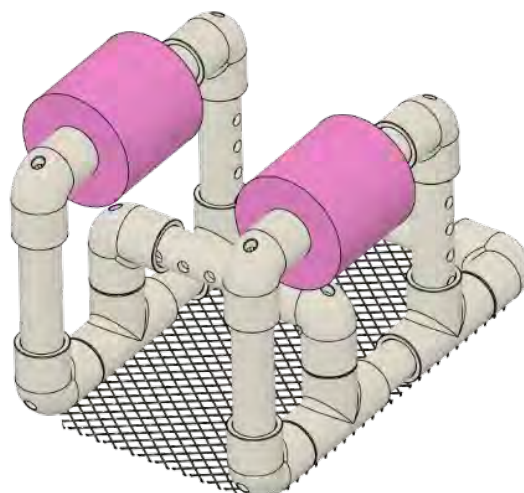

Figure 23

## TASK 3.5B – Mini ROV Frame Assembly

Construct the Mini ROV Frame as shown in Figure 24.

- Assemble one right section (Figure 25) and one left section (Figure 26). These sections are identical except for the orientation of the rear support elbows. Position the thruster mounting pipes with the holes facing as shown.

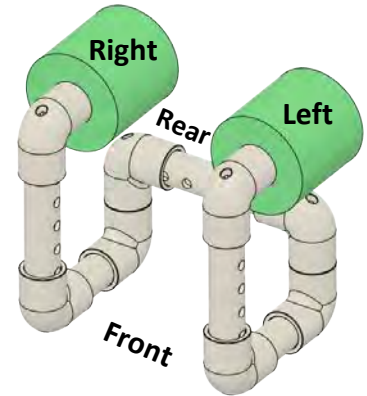

Figure 24

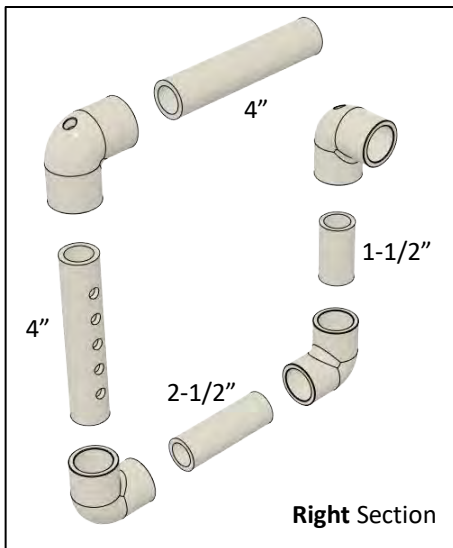

Figure 25

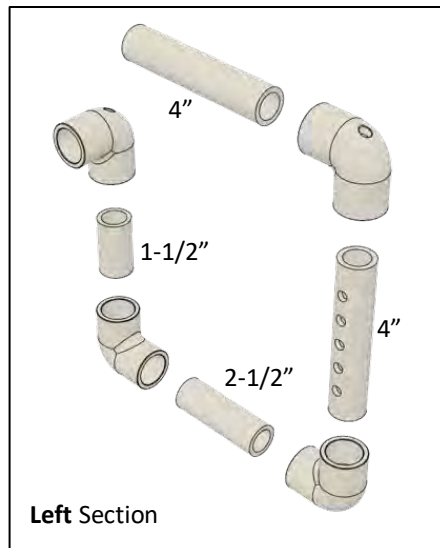

Figure 26

- Connect the two frame side sections using a 4" long thruster mounting pipe and slide 2" long floats on the upper pipes. (Figure 27)

Completed Mini ROV Frame is shown in Figure 24.

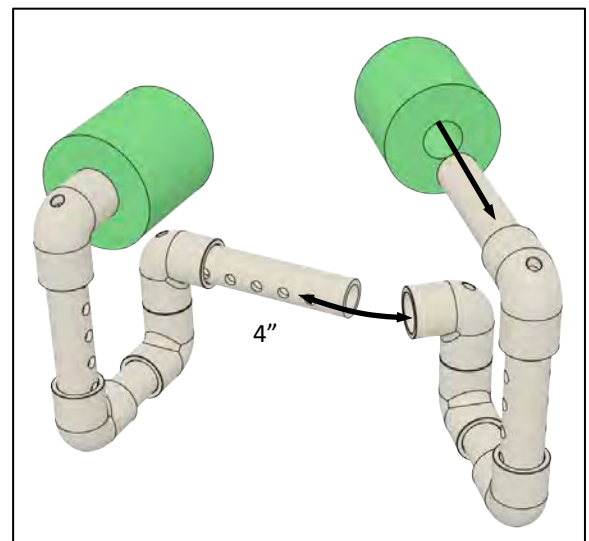

Figure 272

## TASK 3.5C – V-Wing ROV Frame Assembly

Construct the V-Wing ROV Frame as shown in Figure 28.

- Assemble one right section (Figure 29) and one left section (Figure 30). Insert the 4" long pipes into the 2" long floatation pieces before connecting the elbows. Position the thruster mounting pipes with the holes facing as shown.

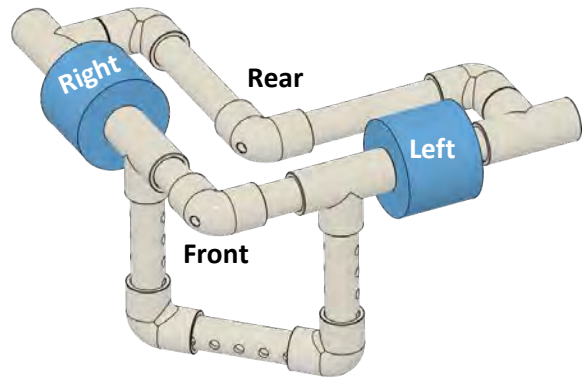

Figure 28

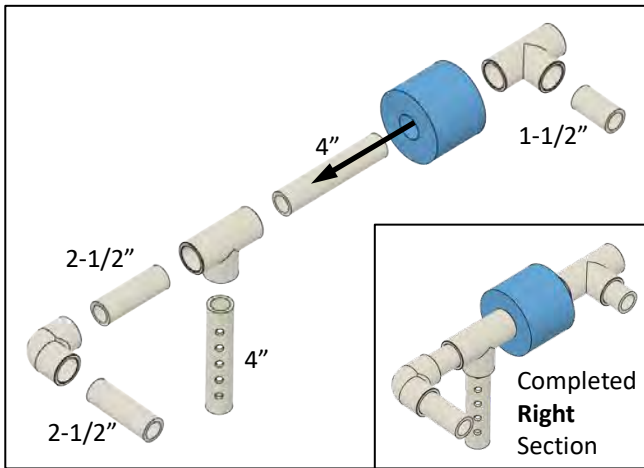

Figure 29

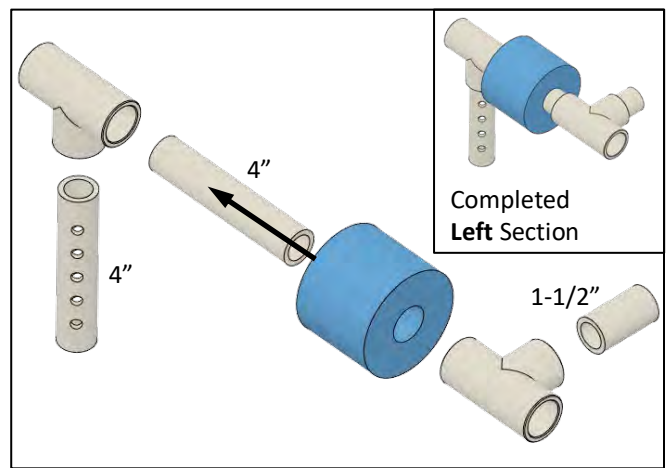

Figure 30

- Assemble the rear frame section. (Figure 31)
- Connect the rear frame section to the left-side frame section. (Figure 32)

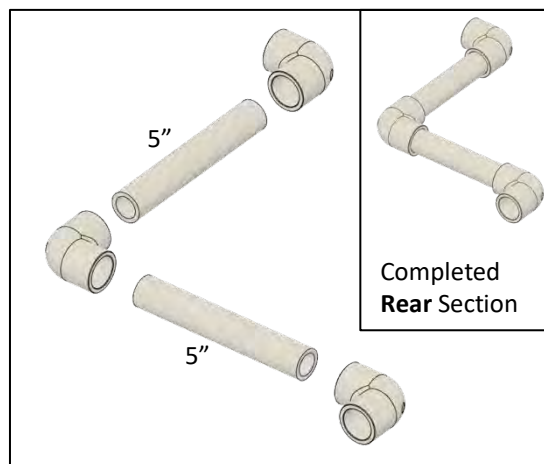

Figure 31

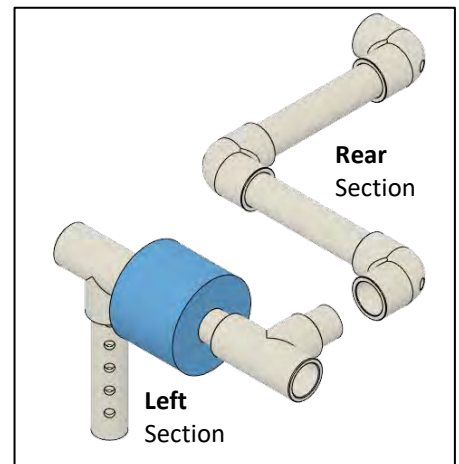

Figure 32

- Connect the rear and left-side frame section from the previous step to the right-side frame section. (Figure 33 & 34)

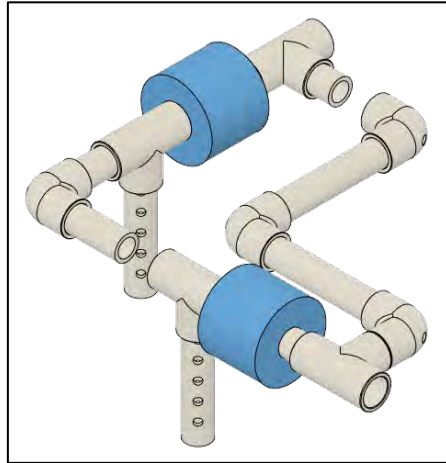

Figure 33

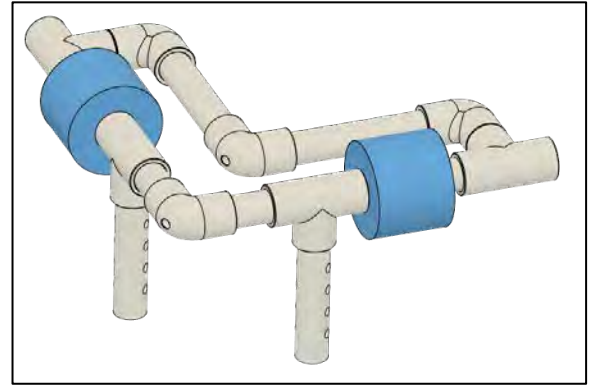

Figure 34

- Connect two elbows to the remaining 4" long thruster mounting pipe. (Figure 35) Make sure the holes in the elbows are facing downward.

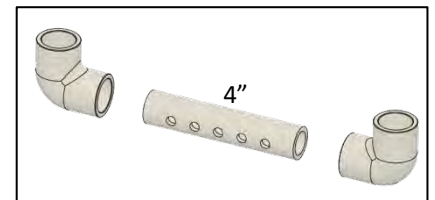

Figure 35

- Connect the assembled motor mount assembly to the main upper frame assembly. (Figure 36)

Completed V-Wing ROV Frame is shown in Figure 37.

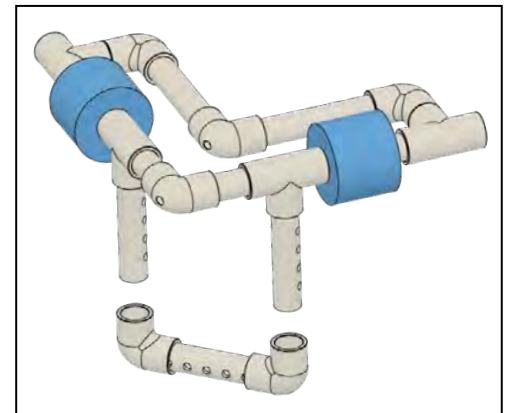

Figure 36

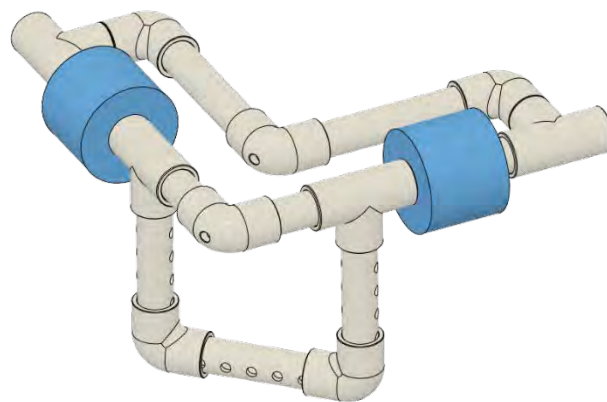

Figure 37

## TASK 3.6 – Final Frame Assembly

- With the frame placed on the floor or on a sturdy tabletop, push down hard on all parts of the frame, turning and pressing from all sides, so that the PVC elbows and pipe sections fit tightly together. A rubber mallet may be used to tap on all the elbows until the ends of the pipe sections bottom out inside the pipe fittings.
- Adjust the sides and the bottom of the frame as needed to square up the vehicle.

Completed Mini ROV (Figure 38) and V-Wing ROV (Figure 39) frames are shown below.



Figure 38

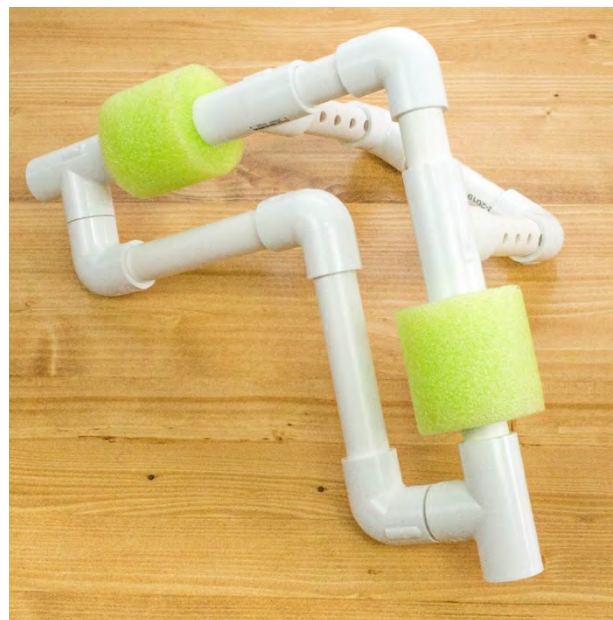

Figure 39

## TASK 3.7 – Attaching the Payload Net (Utility ROV Only)

The payload net is optional and is only used on the Utility ROV design to attach ballasting weights, sensors, and other materials. While the payload net increases the hydrodynamic drag of the ROV, it provides extra stability. Experiment with the use of the payload net when testing your ROV.



### TIP

Do not attach the payload net if you intend to modify the frame.

- Place the payload net underneath the vehicle frame. Trim the net with scissors or diagonal cutting pliers either before or after attaching it to the frame. Leave as little net as possible extending beyond the edges of the frame.
- Attach the net to the frame using the small cable ties, pulling them tight with the needle nose pliers. Make sure the net is tight and flat against the bottom of the SeaPerch. (Figure 40)



Figure 40





Do not place cable ties around any body parts.

- Trim off the ends of the cable ties as flush as possible using diagonal cutting pliers. (Figure 41)

Completed Utility ROV frame is shown below. (Figure 42)



Figure 41



Figure 42

## Congratulations! Frame Assembly Complete



# SeaPerch Build Manual

## Section 4 Final Assembly



### SECTION OBJECTIVE

The last steps in the SeaPerch ROV construction process are to mount the thrusters and the tether cable to the frame and perform some simple vehicle checks and adjustments prior to the first operational use. This section includes ballasting, use, and care of the SeaPerch ROV.

**Completion Estimate:** 3 hours



Figure 1

## Tools Needed



Figure 3

1. Safety Glasses (1 per student & mentor)
2. Diagonal Cutting Pliers
3. Needle Nose Pliers
4. Screwdriver
5. Scissors

## Parts and Other Materials



Figure 3

1. 6" Cable Ties
2. 11" Heavy-Duty Cable Ties
3. Battery and battery charger
4. ROV Frame (completed in Section Three)
5. Thruster Assemblies and Tether Cable (completed in Section Two)
6. Controller and Power Cord (completed in Section One)

### Not Pictured:

- Electrical Tape
- Pool, tank, tub, or large plastic container filled with at least 1 to 2 feet of water for testing and ballasting

**Optional Materials:** Ballast weight (hex nuts, fender washers, and/or machine screws).

## Task 4.1 – Attaching the Thrusters

Each of the three thrusters is mounted to the frame using two heavy-duty cable ties. One cable tie holds the thruster to the pipe. The second cinches the first to secure the thruster tightly to the frame.

The horizontal (left and right) thrusters can be mounted in different positions on the thruster mounting pipes which will affect the pitch of the ROV. (Figure 4) The center mounting position is generally sufficient; however, you may want to experiment with the mounting positions during testing.

**TIP**



If you intend to experiment with the mounting positions, temporarily attach the thrusters with electrical tape. Affix the thrusters using the cable ties, as described below, when the desired positioning is achieved.

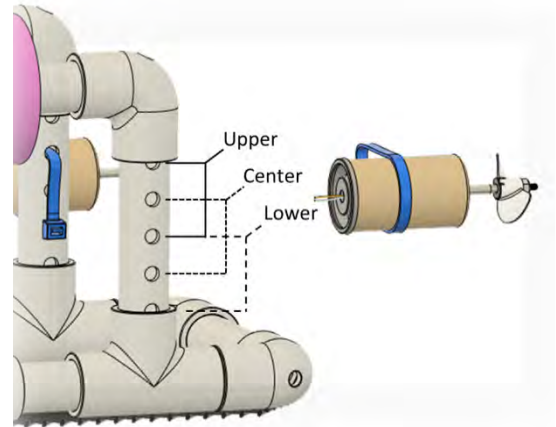

Figure 4

- Review Table 1 and Figure 5 (Utility ROV), Figure 6 (Mini ROV), and Figure 7 (V-Wing ROV) for thruster placement for your chosen design.

Thruster Location	Wire Pair Color
Port (Left)	Blue
Starboard (Right)	Green
Vertical	Orange

Table 1

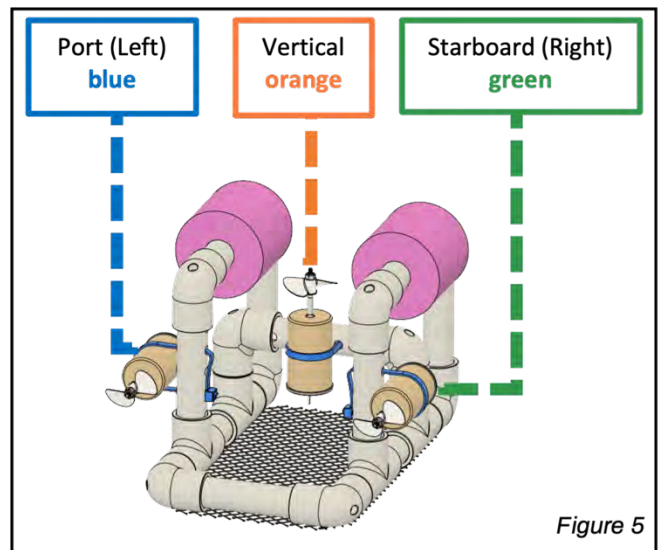

Figure 5

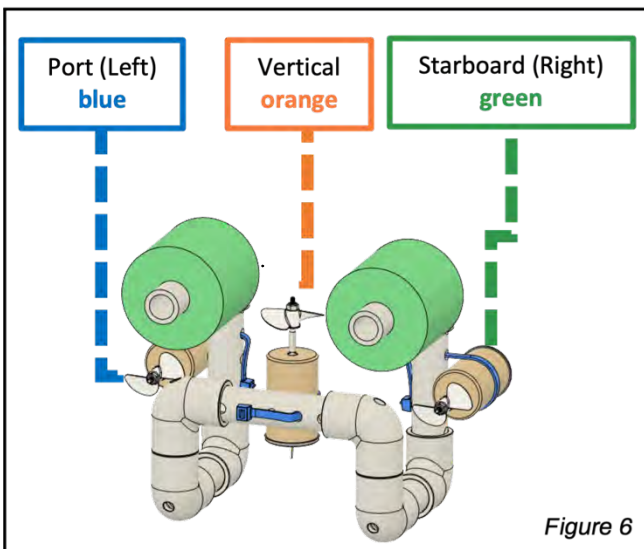

Figure 6

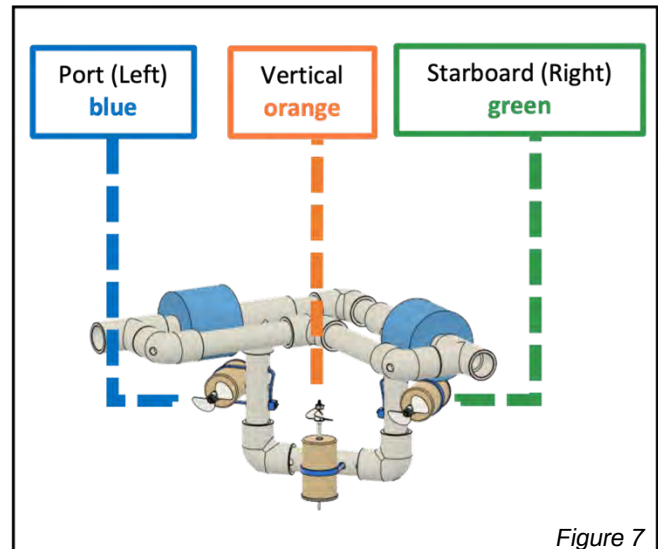

Figure 7



Do not place cable ties around any body parts.

- ❑ Thread an 11" heavy-duty cable tie through two thruster-mounting holes. (Figure 8)
- ❑ Place the appropriate thruster in the loop formed by the cable tie and tighten it around the thruster so that the flat side of the clamp lies flush against the PVC pipe.
- ❑ When certain of placement, pull the cable tie tightly around the thruster case using the needle nose pliers.

**TIP**

Be sure to mount the starboard and port thrusters with their propellers pointing toward the back of the ROV. These thrusters can be placed on the inside or the outside of the SeaPerch frame, depending on your preference.



The vertical thruster can be mounted with its propeller pointing upward or downward. Experiment with the propeller's direction during testing.

- ❑ Cut off the cable tie tails as flush as possible using the diagonal cutting pliers. Avoid leaving sharp ends.
- ❑ Install a second heavy-duty cable tie around the first, between the thruster and the pipe. Use the needle nose pliers to tighten. Cut off the cable tie tails as flush as possible using the diagonal cutting pliers. Avoid leaving sharp ends. (Figure 9)



Figure 8

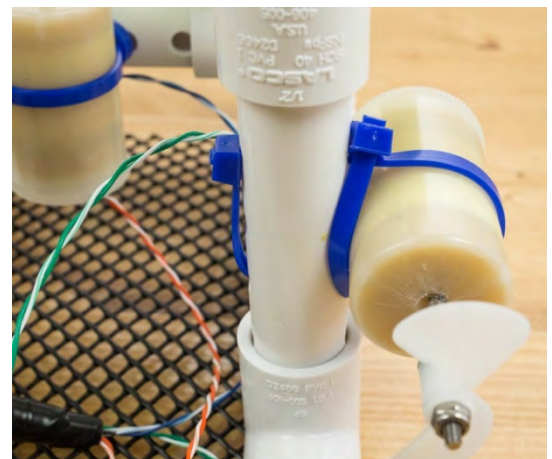

Figure 9

**TIP**

Wrapping the thruster housings with electrical tape provides more grip and prevents them from sliding out of the cable ties. Only one cable tie is needed when using this method. (Figure 10)

Begin by wrapping a piece of electrical tape one time around the middle of the thruster housing. Wrap another piece two or three times around one end of the thruster housing. Repeat on the other end. This forms a trough/channel for the cable tie to rest in.

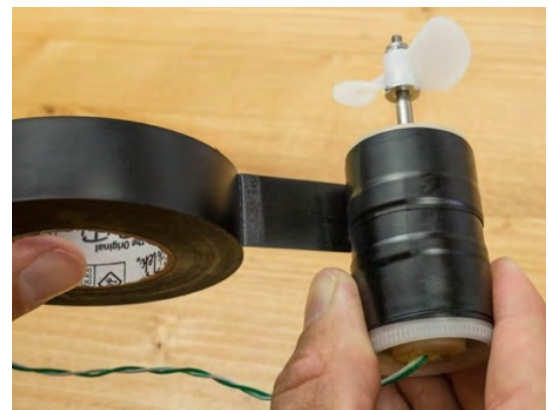

Figure 10

Holes in thruster mounting pipes that are not used for cable ties can be used for easy adjustment of the thruster pointing angles.

- To adjust the thrusters' position in the horizontal plane, insert a screwdriver to gently turn the PVC pipes to orient the thrusters in the desired direction. (Figure 11)

When adjusting the thrusters, consider:

- How do the angles of the thrusters affect the performance of the ROV?
- What angles produce the best forward and backward thrust?
- What angles produce the best turning ability?
- What angles will keep the propellers out of harm's way as the ROV navigates in narrow or crowded places?

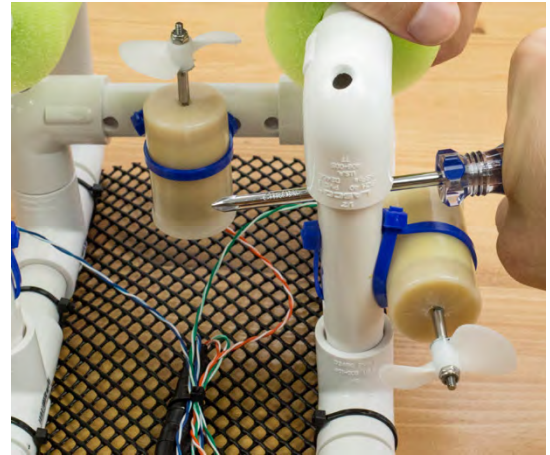

Figure 11

Further adjustments can be made to the thruster angles after the ROV's performance is tested in the water.

## Task 4.2 - Mounting the Tether Cable

For each frame design, use two cable ties in a crossed pattern to secure the tether cable to the ROV frame where it passes over the center of the pipe or connector at the rear of the ROV. Follow instructions below for each frame design.



### SAFETY

Do not place cable ties around any body parts.

### Mounting the Tether Cable to the Utility ROV

- Use a cable tie to attach the colored wire pairs to the waterproofed section of the tether cable as shown. (Figure 12)
- Use two cable ties in a crossed pattern to secure the tether cable to the ROV frame.
- Pull all cable ties tight with needle nose pliers and trim the ends flush with the diagonal cutting pliers, using care not to cut any wires.

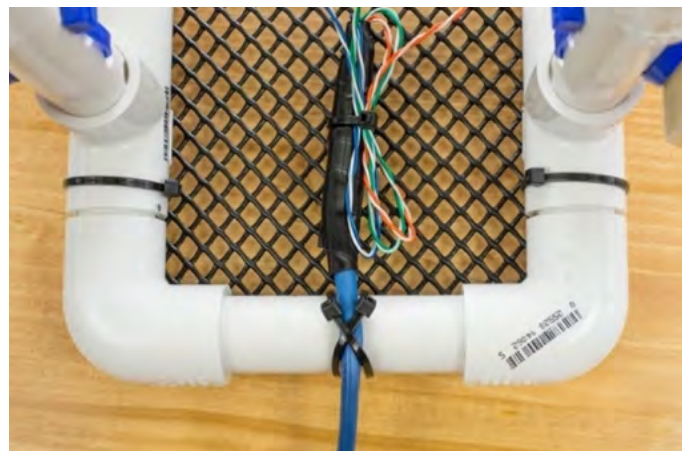

Figure 12

### Mounting the Tether Cable to the Mini ROV

- Loop the tether cable around the vertical thruster as shown, making sure the waterproofed section of the cable is not wrapped around the thruster. (Figure 13)
- Secure the colored wire pairs to the waterproofed section of the cable using a cable tie.
- Use two cable ties in a crossed pattern to secure the tether cable to the ROV frame.
- Pull all cable ties tight with needle nose pliers and trim the ends flush with the diagonal cutting pliers, using care not to cut any wires.



Figure 13

### Mounting the Tether Cable to the V-Wing ROV

- Route the wire pairs toward the front center of the ROV and secure at the upper front elbow using two cable ties. Secure the wire pairs together as needed. (Figure 14)
- Use two cable ties in a crossed pattern to secure the tether cable to the upper rear center elbow.
- Pull all cable ties tight with needle nose pliers and trim the ends flush with the diagonal cutting pliers, using care not to cut any wires.



Figure 14

#### TIP



It is important to keep the tether cable centered and pointing straight back from the ROV so that drag does not pull the ROV more to one side than the other. This could make turning the ROV in one direction more difficult than the other direction. Do not forget to use two crossed cable ties to help keep the tether cable straight.

Consider how the tether cable affects ballasting and trim (discussed in Task 4.4) at different operating depths. At deep depths, or if a camera cable is paired with the standard ROV tether cable, added flotation may be needed on the cable to enable the ROV to surface.

## Task 4.3. - Using the Controller

See the *Tool Usage, Skills, and Safety* section for more information on using the 12-volt lead acid battery.

SAFETY



Make sure hands your hands are dry before proceeding.

- Connect the controller’s power cord to the battery. Connect the alligator clip with the red insulator to the positive battery terminal (red marking and + symbol) and the alligator clip with the black insulator to the negative battery terminal (black marking and - symbol). (Figure 15)
- Connect the tether cable to the controller with the latching prong of the cable oriented in the correct direction. (Figure 16)
- Push the tether cable connector firmly into the controller’s jack until the latching prong clicks in place.

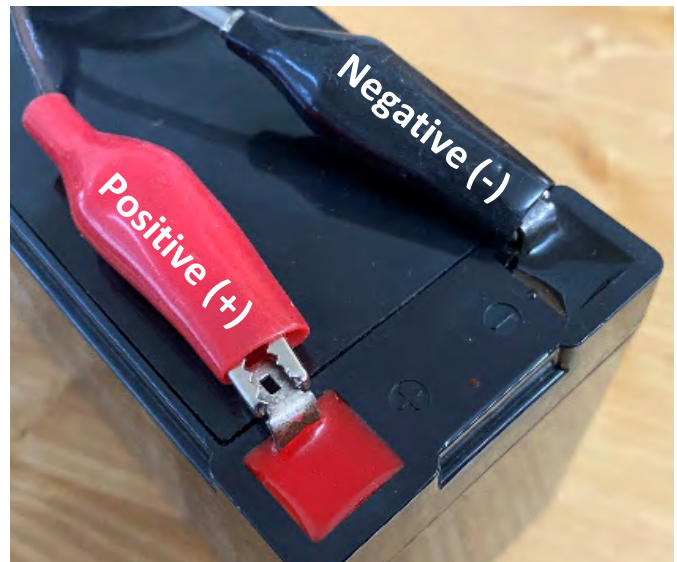

Figure 15

Complete controller and battery setup shown in Figure 17.

- To disconnect the tether cable from the controller, depress the latching prong and pull the connector away from the controller.

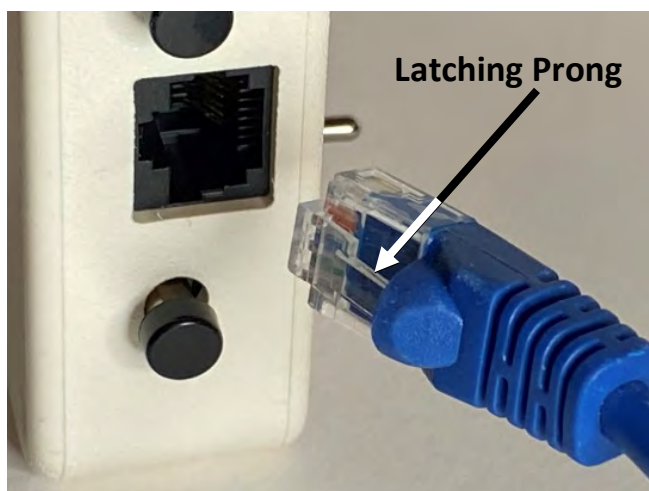

Figure 16



Figure 17



**Controller Operation:** The SeaPerch controller contains two toggle switches and two pushbutton switches. (Figure 18)

- The left toggle switch controls the left (port) thruster.
- The right toggle switch controls the right (starboard) thruster.
- The left and right pushbutton switches control the vertical thruster.

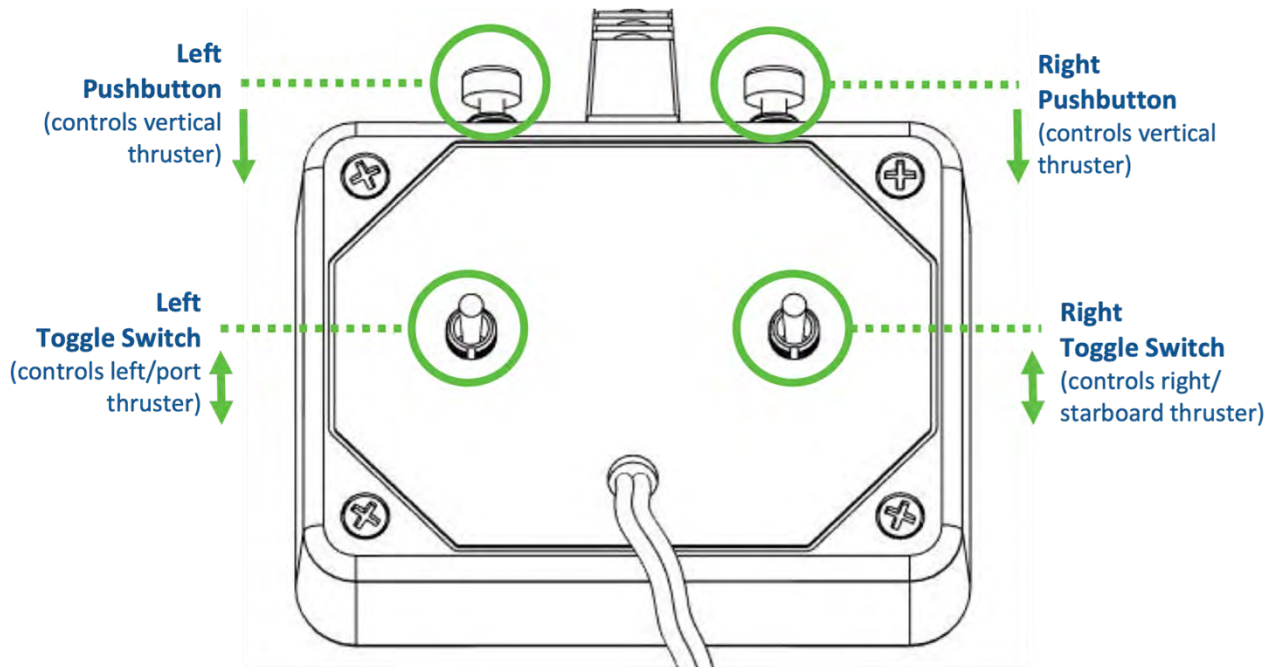

Figure 18

Pushing the toggle switches will propel the ROV in the forward, backward, left, and right directions.

Pushing the pushbuttons will cause the ROV to ascend and descend. Since the vertical thruster is controlled by both pushbuttons, pushing both buttons simultaneously will cause the thruster to stop spinning/yawing.

Figure 19 on the following page includes instructions for maneuvering the ROV using the controller. Additional movements can be completed by combining instructions.

**TIP**



These controller instructions apply only when the propellers of the left (port) and right (starboard) thrusters are pointing directly toward the rear of the ROV. The angles of the thrusters will affect the direction and the turning ability of the ROV.

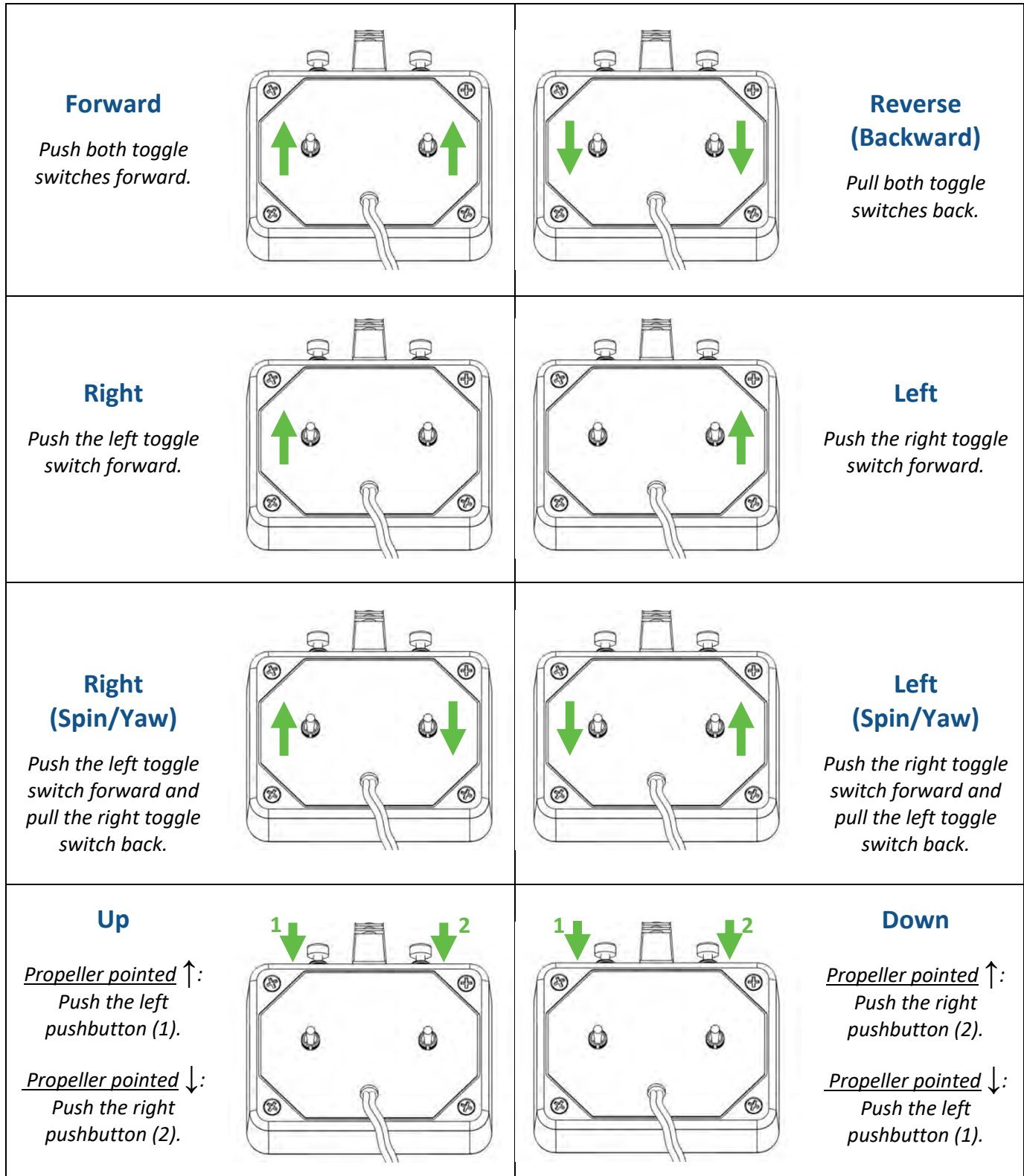

Figure 19



TIP

Be patient! It takes practice to become proficient at maneuvering the ROV.

## Task 4.4 – Buoyancy Adjustment, Ballasting, & Trim Considerations

**Buoyancy and Ballasting Considerations:** The SeaPerch ROV should be slightly positively buoyant when placed in the water, meaning that it sits with the top of the floats about 1/4" or less above the surface and returns to the surface slowly if pushed underwater.

- If the ROV sinks without applying the vertical thruster, it is negatively buoyant and needs more floatation material attached.
- If it has difficulty diving, or floats up to the surface very quickly, it is positively buoyant and needs less floatation.

### TIP

The buoyancy of the SeaPerch ROV is affected by the salinity, depth, and temperature of the water where it is operated. Therefore, the ballast may need to be adjusted for different ROV operating locations and depths.



At depths of six feet or more, the standard foam floats included with the SeaPerch kit will decrease in physical size, absorbing some water due to the increasing water pressure. This may result in reduced displacement and reduced buoyancy. Styrofoam, neoprene rubber, foam pipe insulation or other types of closed-cell foam may be used instead if they can be safely placed in the water.

- All ballast should be secured to the ROV and not move around, which can change the vehicle's trim (explained below). Suspended weights can create excess drag. Certain metals may rust or corrode easily in water (fresh water, pool water, or salt water). Select and place your ballast with these considerations in mind.

On the Mini and V-Wing frame designs, ballast items can be attached to the ROV using cable ties, hooks, or fasteners such as screws or clamps.

On the Utility ROV, ballast weight can be added to the payload net. Try to keep the front center area of the payload net clear to enable the ROV to pick up items without interference. A suggested configuration with fasteners is shown in Figure 20.

Experiment with different ballast materials to see the benefits of the resulting buoyancy. Always use items that can be placed in water without damaging them (or the water). Do some research and choose buoyancy and ballast materials wisely.

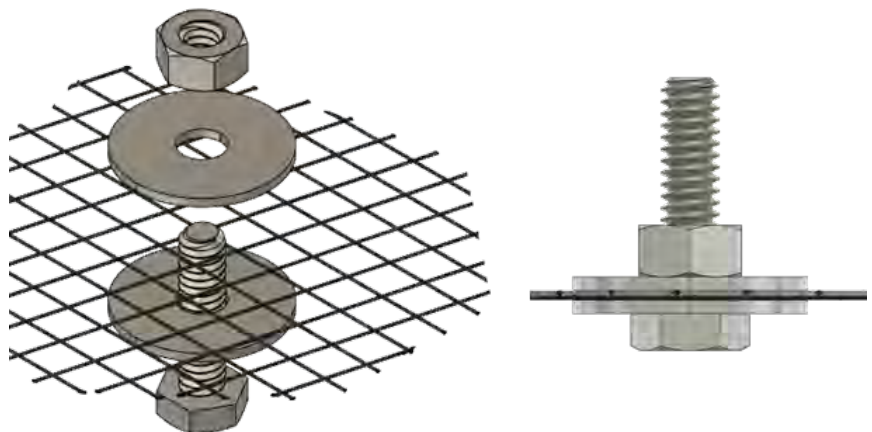

Figure 20

**Trim Considerations:** Trim refers to the floating position of the ROV in the water. Proper trim ensures that the ROV is level in the water and does not tilt side-to-side (roll) or front-to-rear (pitch).

Objects that are lifted by the ROV can put weight on the vehicle and cause it to tilt (pitch) in the direction of the object. (Figure 21)

Anticipating this and setting the ROV to pitch with its front upward would be optimal if objects are lifted from the front of the ROV.

The standard pool noodle floats may have to be secured to prevent them from sliding during ROV operation. Once the pool noodles are adjusted, they can be secured using cable ties or electrical tape.

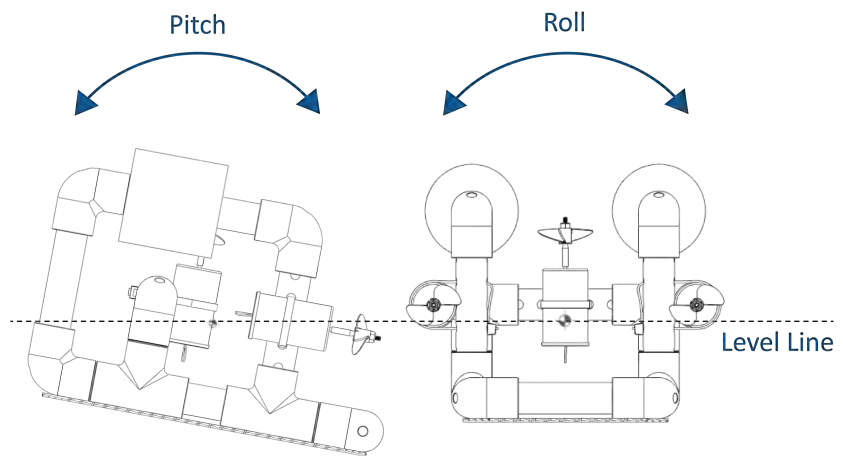

Figure 21

- Using the recommendations discussed in this section, place your ROV in at least 1-2 feet of water and begin the process until the vehicle is slightly positively buoyant. Add or subtract floats and weights. Move the floats and weights to different positions on the ROV's frame. Adjust the thruster pointing angles as necessary.

These adjustments may take several design iterations. Document each change by measuring depth in the water. How was the ROV's position in the water affected by the changes?

## Task 4.5 - Post-Run Cleaning & Maintenance

- Rinse the ROV well with fresh water after each use. Both pool water and saltwater can be corrosive to thrusters and metal parts. If possible, submerge the ROV in a tub of fresh water and run the thrusters for a few seconds to clear corrosive materials from the motor shafts.
- Remove biological or other materials picked up in natural marine environments before storing the ROV as they can be damaging and difficult to clean if left to dry on the ROV.



### TIP

Spraying the shaft area of each thruster with a protective agent such as WD-40 after each use will help to lengthen the operating life of the vehicle.

- Allow the vehicle to dry completely before storage.

# Congratulations!

## Final Assembly Complete

# SeaPerch Build Manual

## Section 5 Engineering Design Process



### SECTION OBJECTIVE

You now have a working SeaPerch ROV (congratulations!) and may be wondering what is next? Now is when the fun really begins!



## TASK 5.1 – Learn about the Engineering Design Process

Take a moment to reflect on all of the new skills and knowledge you have gained during your build. Now take all of that, along with the PVC pipe left over from the build (you should have at least a 12” section of unused pipe) and re-configure your ROV to complete a specific task, solve a problem, improve its maneuverability, or increase its speed.

In this part of your build, you will use the **Engineering Design Process (EDP)**, a cycle of steps that are used to find a solution to an engineering problem. These steps of the EDP are:

**Ask.** Identify and define the problem. What criteria are important? Research past ideas and relevant concepts.

**Imagine.** With your team, consider possible solutions.

**Plan.** Formalize the best solution, based on the time and resources you have.

**Create.** Build a prototype.

**Test.** Record and evaluate results based on the criteria identified in the first step.

**Improve.** Repeat steps as needed

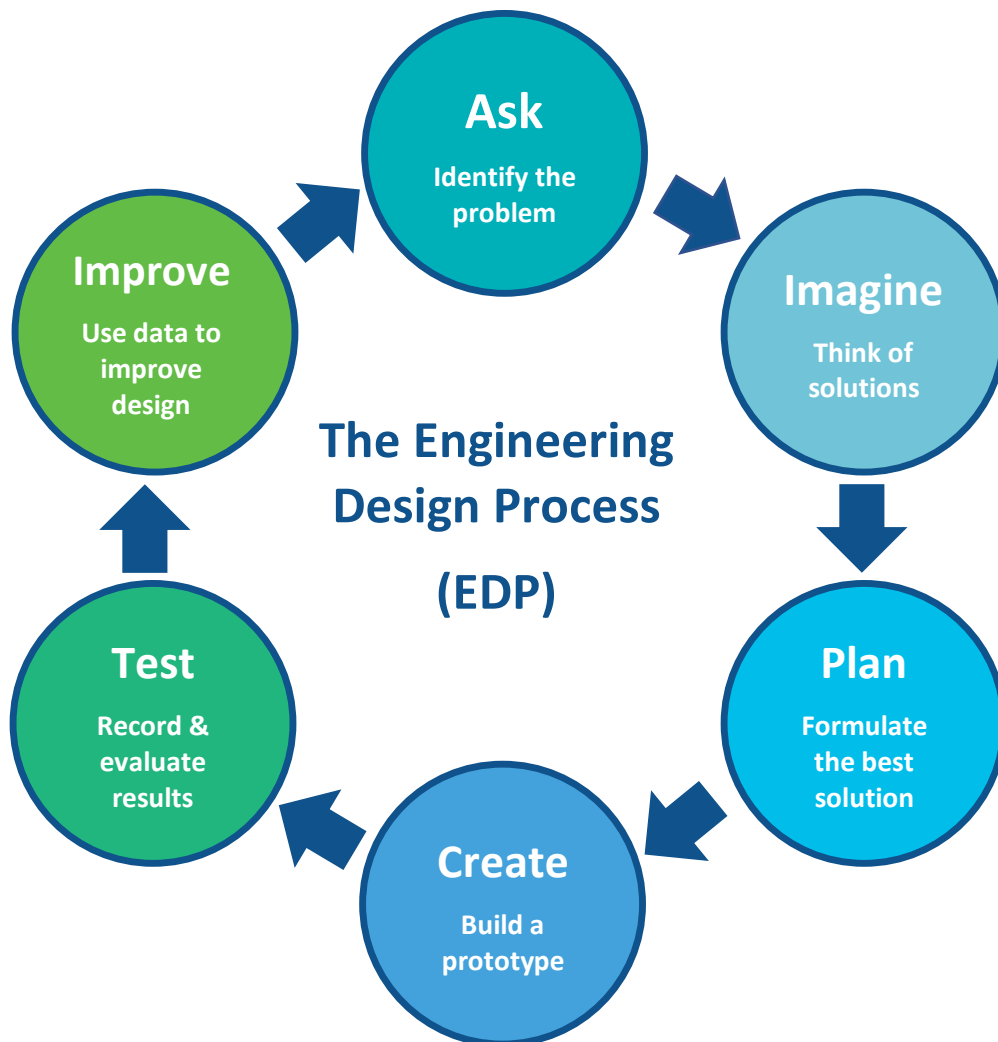



## LEARN MORE ABOUT THE ENGINEERING DESIGN PROCESS

The Engineering Design Process (EDP) is a purposeful, systematic process undertaken with a specific goal in mind. The process is not linear; instead, it is iterative, meaning that the steps do not have to be followed in order and can be repeated as many times as needed to continually improve your design. At its heart, the EDP includes research into past solutions, open-minded problem solving, critical thinking, teamwork, and creativity.

The EDP is not just for engineering and can also be used to solve everyday problems. Have you ever written a paper for school and went through several rounds of editing and revising? Have you ever worked on a group project to get a job done? Have you ever tried a new recipe that did not turn out as expected, so you made a few tweaks the next time to achieve better results? If so, you have already used the EDP!

Learn more about the EDP at [www.seaperch.org/design-process](http://www.seaperch.org/design-process)

## TASK 5.2 – Ask

### □ Identify a problem.

You cannot design a solution until you clearly identify the problem. Start with a specific idea and avoid being vague or ambiguous (i.e., “How can we make this ROV *better*?”). To identify the best solution, narrow your problem down to something that can be tested and is measurable (i.e., “How can we make this ROV *lighter*?”).

Need some inspiration? Check out real-world project ideas from SeaPerch in the Wild at [www.seaperch.org/in-the-wild](http://www.seaperch.org/in-the-wild) or use a past SeaPerch competition task ([www.seaperch.org/competition](http://www.seaperch.org/competition)) as a starting point.

### □ Conduct research on the problem.

Explore, investigate, and research existing solutions *within and outside of* the problem area that may be adaptable to your needs. Speak to experts and specialists in the field; learn from their successes and failures. Use the internet and books to find information to help you frame your problem statement.

Questions to guide your thinking during this step may include:

- What is the need or problem?
- Why is it important to solve this problem?
- What do you want to design?
- What do you want to accomplish?
- What are the criteria or requirements that must be met (durability, reliability, operating range, weight, etc.)?
- What are the limitations, constraints, or parameters (i.e., cost/budget, size, material, etc.)?

### □ Start an engineering notebook.

Use a notebook to start consolidating the information you collect through your research. As you conduct research, reference it in your notebook and document the refinement of your problem statement. This will be the basis of the next steps in your design improvement.

Engineering notebooks include, at a minimum:

- A clearly articulated project or problem to be solved
- Project constraints and parameters
- Detailed design ideas and drawings
- Procedures to implement and test the designs
- Test results
- Recommendations for design modifications
- Proposed future steps



## LEARN MORE ABOUT ENGINEERING NOTEBOOKS

Engineering notebooks are used by engineers to carefully and systematically document the design steps, procedures, and test results taken to solve engineering problems. Engineering notebooks also provide a legal document that can be used as proof of invention for products.

## TASK 5.3 – Imagine

### **Brainstorm!**

With your team, generate as many ideas as possible and write them down. During this step, no idea is a bad idea! Be mentally nimble. Go for *quantity* of ideas over *quality*. Postpone judgement and criticism of all ideas at this point. The best solution may not be the most obvious. Determine which ideas meet your project requirements and can be accomplished using the time, supplies, and talents that your team has.

### **Create conceptual designs.**

Begin to document your ideas with sketches, drawings, graphs, or charts in your engineering notebook. Illustrate your possible solutions with design drawings.

## TASK 5.4 – Plan

This phase includes three steps to assist you in formalizing the approach to your design solution.

### **Revisit your problem statement.**

Reconsider the needs and constraints identified during the “Ask” phase and review your research. Use this step to ensure that you have a good understanding of what problem your ROV will be addressing so that you can focus your design on that specific task.

Are there any specific aspects of the problem that would be helpful to further research? If so, revisit Task 5.2 and add to your existing research. A thorough understanding of your problem statement is vital as you move into the next steps.

### **Select a solution.**

Review the conceptual designs you created in Task 5.3 as well as your research and select the solution that best meets all the requirements and restraints you identified.

### □ Prepare your plan.

With the goal of eventually building a prototype in the “Create” phase, use your engineering notebook to prepare and document your plan.

- Create detailed design drawings.
- Make a list of materials you will need to build your design.
- Document fabrication steps and procedures.
- Develop plans to test your design. Include specific data that you will need to collect to track the performance of your ROV.

## TASK 5.5 – Create

### □ Build your design.

Bring your design to life! Collect the materials you listed in the last task and follow the fabrication steps and procedures you outlined. By the end of this task, you should have a new version of your ROV ready to test.

As you build, you may find aspects of your plan that do not come together as expected. If there are any flaws in your design, it is best to find and remedy them during this phase as it is more cost-effective to make corrections now.

### □ Document your design.

As you build and come to your test-ready design, make sure to document your final product before moving to the next step. Having a detailed accounting of your design will be helpful as you assess and potentially modify your design after testing. Documentation should include:

- Photos and updated sketches of your fabricated prototype
- CAD graphics, charts, etc.
- References and explanations of all graphics
- Clear labels for relevant parts in drawings

## TASK 5.6 – Test

### □ Conduct testing on your design.

A common saying in engineering is “fail fast” which means to identify flaws and failure points early on to help keep material and manpower costs down. Trust the data you collect, even if it tells you something you do not want to hear or did not expect!

Following the plan you developed in Task 5.4, test your design. Collect multiple sets of data that will assist you in quantifying the performance of your new design. In addition to specific performance data, test the durability and quality of your design.

- Determine if the prototype works. Talk about what works and what does not work.
- Determine if the prototype solves the need.



### Document test results.

Both during and soon following your in-water testing, carefully document test results in your engineering notebook. Create charts, graphs, and other visuals to illustrate your test results. As you document your test results:

- Use ample text and graphics.
- Provide detailed explanations for all graphics.
- Clearly label relevant parts in drawings.

### Analyze your test results.

Review your test results to determine if your design worked as expected. Discuss what worked and what did not work.

## TASK 5.7 – Improve

Based on testing, it is likely that you found areas for additional refinement and improvement. Depending on your specific results and findings, revisit the above tasks as often as necessary until you come to a final design solution that is the best it can be.

During this task you could:

- Revisit your problem statement and conduct additional research (Task 5.2 – Ask).
- Return to brainstorming and draft a design to improve your solution (Task 5.3 – Imagine).
- Update your plan to include new or revised materials and fabrication approaches (Task 5.4 – Plan).
- Make design revisions to your ROV (Task 5.5 – Create).
- Return to testing and collect additional data to evaluate (Task 5.6 – Test).

**More Information:** For additional helpful resources, visit the Resource Library on the SeaPerch website, [www.seaperch.org/library](http://www.seaperch.org/library).

Consider sharing your design with the SeaPerch community here: [www.seaperch.org/seaperch-onshore](http://www.seaperch.org/seaperch-onshore).

**Congratulations!**  
**You now have your own unique ROV**





# SeaPerch Build Manual

## Notes





Let's build something awesome.